



DUAL BAND FM TRANSCEIVER

FT-7800R

OPERATING MANUAL



VERTEX STANDARD CO., LTD.

4-8-8 Nakameguro, Meguro-Ku, Tokyo 153-8644, Japan

VERTEX STANDARD

US Headquarters

10900 Walker Street, Cypress, CA 90630, U.S.A.

YAESU EUROPE B.V.

P.O. Box 75525, 1118 ZN Schiphol, The Netherlands

YAESU UK LTD.

Unit 12, Sun Valley Business Park, Winnall Close
Winchester, Hampshire, SO23 0LB, U.K.

VERTEX STANDARD HK LTD.

Unit 5, 20/F., Seaview Centre, 139-141 Hoi Bun Road,
Kwun Tong, Kowloon, Hong Kong

Contents

Introduction	1	Memory Operation	32
Specifications	2	Regular Memory Channel Operation	32
Accessories & Options	3	Memory Storage	32
Supplied Accessories	3	To Append an Alpha-numeric “Tag” to a Memory	33
Optional Accessories	3	Storing Independent Transmit Frequencies (“Odd Splits”)	33
Installation	4	Memory Recall	34
Preliminary Inspection	4	Memory Offset Tuning	34
Installation Tips	4	Deleting Memories	35
Safety Information	5	HOME Channel Memory	35
Antenna Considerations	6	Memory Bank Operation	36
Mobile Installation	8	Memory Only Mode	37
Mobile Power Connections	9	Hyper Memory Channel Operation	38
Mobile Speakers	9	Hyper Memory Storage	38
Base Station Installation	10	Hyper Memory Recall	38
AC Power Supplies	10	Weather Broadcast Channel Operation	39
Packet Radio Terminal Node Controller	10	Scanning	40
Front Panel Controls & Switches	12	Setting the Scan-Resume Technique	40
Side Panel Connection & Knob	14	VFO Scanning	41
LCD	14	Memory Scanning	42
Rear Panel Connections	15	How to Skip (Omit) a Channel During Memory Scan Operation	42
MH-48A6J Microphone	16	Preferential Memory Scan	43
MH-42B6JS Microphone	18	Memory Bank Scan	44
Basic Operation	20	Weather Alert Scan	44
Turning the Transceiver On and Off	20	Programmable (Band Limit) Memory Scan	45
Adjusting the Audio Volume Level and Squelch Setting	20	“Priority Channel” Scanning (Dual Watch)	46
Selecting the Operating Band	20	VFO Priority	46
Frequency Navigation	21	Memory Priority	46
Transmission	22	HOME Priority	46
Changing the Transmitter Power Level	22	WX Priority	47
Advanced Operation	23	Priority Revert Mode	47
Lock Feature	23	Smart Search	48
Keyboard Beeper	23	ARTS™: Auto Range Transponder System	50
Display Brightness	24	Basic ARTS Setup and Operation	50
RF Squelch	24	ARTS Polling Time Options	51
Channel Step Selection	25	ARTS Alert Beep Option	51
Receiving Mode Selection	25	CW Identifier Setup	52
Repeater Operation	26	DTMF Autodialer Operation	54
Repeater Shifts	26	Internet Connection Feature	56
Automatic Repeater Shift (ARS)	26	Miscellaneous Settings	58
Manual Repeater Shift Activation	27	Time-Out Timer	58
Changing the Default Repeater Shift	27	Automatic Power Off	58
CTCSS/DCS Operation	28	MIC Gain Control	59
CTCSS Operation	28	Programming the Key Assignment	60
DCS Operation	29	DCS Code Inversion	62
Tone Search Scanning	30	Reset Procedure	63
Split Tone Operation	31	Cloning	64
		Menu (“Set”) Mode	65
		“Auto” Mode Preset Operating Parameters ..	76

INTRODUCTION

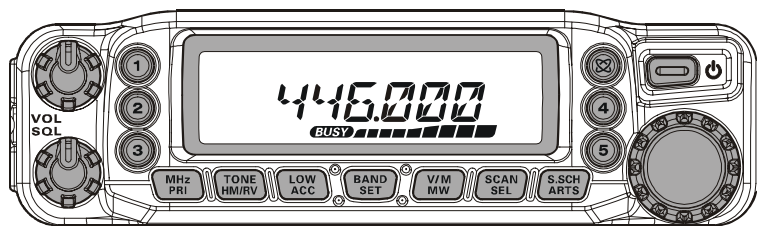

The **FT-7800R** is a ruggedly-built, high quality Dual Band FM transceiver providing 50 Watts of power output on the 144 MHz Amateur band and 40 Watts on the 430 MHz Amateur band.

The high power output of the **FT-7800R** is produced by its RD70HVF1 Power MOS FET amplifier, with a direct-flow heat sink and thermostatically-controlled cooling fan maintaining a safe temperature for the transceiver's circuitry.

Featuring 1055 memory channels which enable the storage of Independent Transmit Frequencies ("Odd Split"), and built-in CTCSS and DCS encoder/decoder circuits, the **FT-7800R** includes also provision for remote-head mounting, utilizing the optional **YSK-7800** Separation Kit, which allows installation even in the most compact of cars.

Additional features include a convenient access key for Vertex Standard's WIRES™ (Wide-Coverage Internet Repeater Enhancement System), a transmit Time-Out Timer (TOT), Automatic Power-Off (APO), Automatic Repeater Shift (ARS), plus Yaesu's exclusive ARTS™ (Auto-Range Transponder System) which "beeps" the user when you move out of communications range with another ARTS™ equipped station. And an RF squelch circuit allows the owner to set the squelch to open at a programmable setting of the S-Meter, thus reducing guesswork in setting the squelch threshold.

We recommend that you read this manual in its entirety, so as to understand fully the many features of your new **FT-7800R** transceiver.

SPECIFICATIONS

General

Frequency Range:	RX: 108.000 - 520.000 MHz, 700.000 - 999.990 MHz (Cellular Blocked) TX: 144.000 - 148.000 MHz or 144.000 - 146.000 MHz, 430.000 - 450.000 MHz or 430.000 - 440.000 MHz
Channel Steps:	5/10/12.5/15/20/25/50/100 kHz
Modes of Emission:	F3E, F2D, F2A
Antenna Impedance:	50 Ohms, unbalanced (Antenna Duplexer built-in)
Frequency Stability:	±5 ppm @ 14 °F ~ +140 °F (-10 °C ~ +60 °C)
Operating Temperature Range:	-4 °F ~ +140 °F (-20 °C ~ +60 °C)
Supply Voltage:	13.8 VDC (±15 %), negative ground
Current Consumption (Approx.):	RX: 0.5 A (Squelched) TX: 8.5 A
Case Size (W x H x D):	5.5" x 1.6" x 6.6" (140 x 41.5 x 168 mm) (w/o knobs & connectors)
Weight (Approx.):	2.2 lb. (1 kg)

Transmitter

Output Power:	50/20/10/5 W (144 MHz) 40/20/10/5 W (430 MHz)
Modulation Type:	Variable Reactance
Maximum Deviation:	±5 kHz, ±2.5 kHz
Spurious Radiation:	At least -60 dB below
Microphone Impedance:	2 kΩ
DATA Jack Impedance:	10 kΩ

Receiver

Circuit Type:	Double-conversion superheterodyne
Intermediate Frequencies:	45.05 MHz/450 kHz
Sensitivity:	0.8 μV (TYP) for 10 dB SN (108 - 137 MHz, AM) 0.2 μV for 12 dB SINAD (137 - 150 MHz, FM) 0.25 μV for 12 dB SINAD (150 - 174 MHz, FM) 0.3 μV (TYP) for 12 dB SINAD (174 - 222 MHz, FM) 0.25 μV (TYP) for 12 dB SINAD (222 - 300 MHz, FM) 0.8 μV (TYP) for 10 dB SN (300 - 336 MHz, AM) 0.25 μV for 12 dB SINAD (336 - 420 MHz, FM) 0.2 μV for 12 dB SINAD (420 - 520 MHz, FM) 0.4 μV (TYP) for 12 dB SINAD (800 - 900 MHz, FM) 0.8 μV (TYP) for 12 dB SINAD (900 - 999.99 MHz, FM)
Squelch Sensitivity:	Better than 0.16 μV
Selectivity (-6dB/-60dB):	12 kHz/30 kHz
Maximum AF Output:	2 W @ 8 Ω for 10% THD
AF Output Impedance:	4-16 Ω

Specifications are subject to change without notice, and are guaranteed within the 144 and 430 MHz amateur bands only. Frequency ranges will vary according to transceiver version; check with your dealer.

ACCESSORIES & OPTIONS

SUPPLIED ACCESSORIES

Microphone MH-48A6J	1
Mobile Mounting Bracket MMB-36	1
DC Power Cord w/Fuse (T9021715)	1
Spare Fuse 15 A (Q0000081)	2
Operating Manual	1
Warranty Card	1

OPTIONAL ACCESSORIES

MH-48A6J	DTMF Microphone ^{※1}
MH-42B6JS	Hand Microphone ^{※1}
YSK-7800	Separation Kit
MEK-2	Microphone Extension Kit ^{※2}
MLS-100	High-Power External Speaker
FP-1023	AC Power Supply (25A: USA only)
FP-1030A	AC Power Supply (30A)
CT-39A	Packet Interface Cable

Availability of accessories may vary. Some accessories are supplied as standard per local requirements, while others may be unavailable in some regions. Consult your Yaesu dealer for details regarding these and any newly-available options. Connection of any non-Yaesu-approved accessory, should it cause damage, may void the Limited Warranty on this apparatus.

- ※1: If you replace the microphone from the **MH-48A6J** to **MH-42B6JS** or vice versa, change the setting of Menu #22 (MIC). See page 71 for details.
- ※2: When using the **MH-48A6J** or **MH-42B6JS** microphone in conjunction with the **MEK-2**, in some cases, the programmable key functions (**MH-48A6J**: [P1] through [P4], **MH-42B6JS**: [ACC], [P], [P1], and [P2]) may operate erratically.

INSTALLATION

This chapter describes the installation procedure for integrating the **FT-7800R** into a typical amateur radio station. It is presumed that you possess technical knowledge and conceptual understanding consistent with your status as a licensed radio amateur. Please take some extra time to make certain that the important safety and technical requirements detailed in this chapter are followed closely.

PRELIMINARY INSPECTION

Inspect the transceiver visually immediately upon opening the packing carton. Confirm that all controls and switches work freely, and inspect the cabinet for any damage. Gently shake the transceiver to verify that no internal components have been shaken loose due to rough handling during shipping.

If any evidence of damage is discovered, document it thoroughly and contact the shipping company (or your local dealer, if the unit was purchased over-the-counter) so as to get instructions regarding the prompt resolution of the damage situation. Be certain to save the shipping carton, especially if there are any punctures or other evidence of damage incurred during shipping; if it is necessary to return the unit for service or replacement, use the original packing materials but put the entire package inside another packing carton, so as to preserve the evidence of shipping damage for insurance purposes.

INSTALLATION TIPS

To ensure long life of the components, be certain to provide adequate ventilation around the cabinet of the **FT-7800R**.

Do not install the transceiver on top of another heat-generating device (such as a power supply or amplifier), and do not place equipment, books, or papers on top of the **FT-7800R**. Avoid heating vents and window locations that could expose the transceiver to excessive direct sunlight, especially in hot climates. The **FT-7800R** should not be used in an environment where the ambient temperature exceeds +140 °F (+60 °C).

INSTALLATION

SAFETY INFORMATION

The **FT-7800R** is an electrical apparatus, as well as a generator of RF (Radio Frequency) energy, and you should exercise all safety precautions as are appropriate for this type of device. These safety tips apply to any device installed in a well-designed amateur radio station.



Never allow unsupervised children to play in the vicinity of your transceiver or antenna installation.



Be certain to wrap any wire or cable splices thoroughly with insulating electrical tape, to prevent short circuits.



Do not route cables or wires through door jambs or other locations where, through wear and tear, they may become frayed and shorted to ground or to each other.



Do not stand in front of a directional antenna while you are transmitting into that antenna. Do not install a directional antenna in any location where humans or pets may be walking in the main directional lobe of the antenna's radiation pattern.



In mobile installations, it is preferable to mount your antenna on top of the roof of the vehicle, if feasible, so as to utilize the car body as a counterpoise for the antenna and raise the radiation pattern as far away from passengers as possible.



During vehicular operation when stopped (in a parking lot, for example), make it a practice to switch to Low power if there are people walking nearby.



Never wear dual-earmuff headphones while driving a vehicle.



Do not attempt to drive your vehicle while making a telephone call on an autopatch using the DTMF microphone. Pull over to the side of the road, whether dialing manually or using the auto-dial feature.

INSTALLATION

ANTENNA CONSIDERATIONS

The **FT-7800R** is designed for use with antennas presenting an impedance of near 50 Ohms at all operating frequencies. The antenna (or a 50 Ohm dummy load) should be connected whenever the transceiver is turned on, to avoid damage that could otherwise result if transmission occurs accidentally without an antenna.

Ensure that your antenna is designed to handle 50 Watts of transmitter power. Some magnetic-mount mobile antennas, designed for use with hand-held transceivers, may not be capable of withstanding this power level. Consult the antenna manufacturer's specification sheet for details.

Most all FM work is performed using vertical polarization. When installing a directional antenna such as a Yagi or Cubical Quad, be certain to orient it so as to produce vertical polarization, unless you are engaged in a special operating situation where horizontal polarization is used. In the case of a Yagi antenna, orient the elements vertically for vertical polarization; for a Cubical Quad, the feedpoint should be at the center of one of the vertical sides of the driven element (or at a side corner, in the case of a diamond-shaped Cubical Quad).

Note that this transceiver is designed with wide frequency coverage in the VHF/UHF spectrum. For general listening, you may wish to have a broadband antenna such as a discone available, as a directional antenna such as a Yagi will have degraded performance outside the Amateur band for which it is designed.

Excellent reference texts and computer software are available for the design and optimization of VHF and UHF antennas. Your dealer should be able to assist you with all aspects of your antenna installation requirements.

Use high-quality 50 Ohm coaxial cable for the lead-in to your **FT-7800R** transceiver. All efforts at providing an efficient antenna system will be wasted if poor quality, lossy coaxial cable is used. Losses in coaxial lines increase as the frequency increases, so an 8-meter-long (25') coaxial line with under 1 dB of loss at 144 MHz may have a loss of 3 dB or more at 446 MHz; choose your coaxial cable carefully based on the installation location (mobile vs. base) and the overall length of the cable required (for very short runs of cable in a mobile installation, the smaller, more flexible cable types may be acceptable).

INSTALLATION

ANTENNA CONSIDERATIONS

For reference, the chart below shows approximate loss figures for typically-available coaxial cables frequently used in VHF/UHF installations.

Loss in dB per 30 m (100 feet) for Selected 50-Ohm Coaxial Cables

(Assumes 50-Ohm Input/Output Terminations)

CABLE TYPE	Loss: 144 MHz	Loss: 430 MHz
RG-58A	6.5	> 10
RG-58 Foam	4.7	8
RG-213	3.0	5.9
RG-8 Foam	2.0	3.7
Belden 9913	1.5	2.9
Times Microwave LMR-400	1.5	2.6
7/8" "Hardline"	0.7	1.3

Loss figures are approximate; consult cable manufacturers' catalogs for complete specifications.

In outdoor installations, be certain to weatherproof all connectors thoroughly, as water entering a coaxial cable will cause losses to escalate rapidly, thus diminishing your communications effectiveness. The use of the shortest possible length of the highest quality coaxial cable that fits within your budget will ensure the best performance from your **FT-7800R**.

INSTALLATION

MOBILE INSTALLATION

The **FT-7800R** must only be installed in vehicles having a 13.8 Volt negative ground electrical system. Mount the transceiver where the display, controls, and microphone are easily accessible, using the supplied **MMB-36** mounting bracket.

The transceiver may be installed in almost any location, but should not be positioned near a heating vent nor anywhere where it might interfere with driving (either visually or mechanically). Make sure to provide plenty of space on all sides of the transceiver so that air can flow freely around the radio's case. Refer to the diagrams showing proper installation procedures.

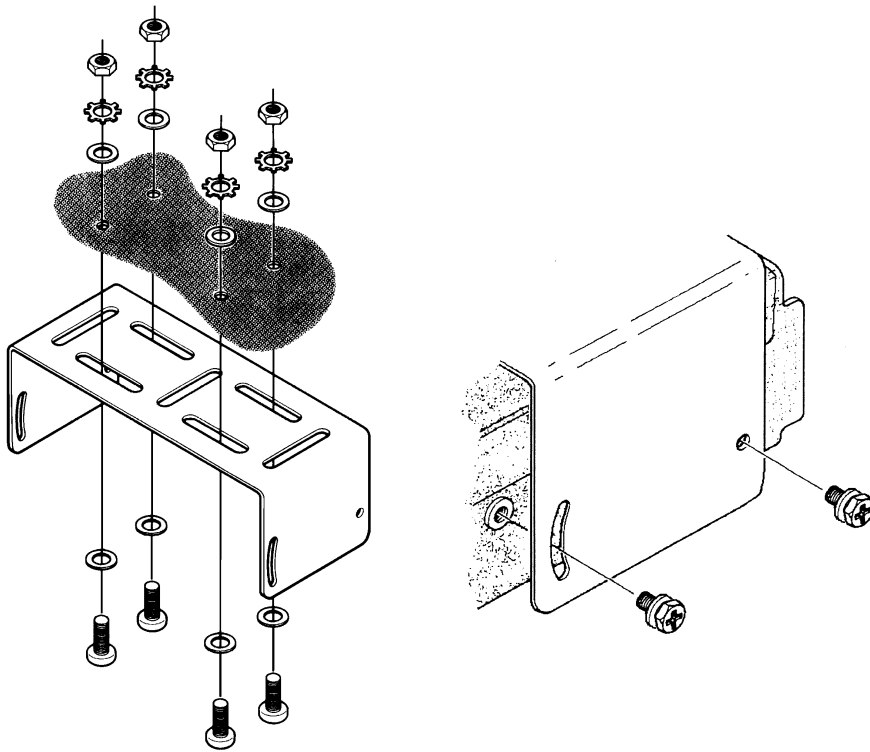

INSTALLATION

MOBILE INSTALLATION

Mobile Power Connections

To minimize voltage drop and avoid blowing the vehicle's fuses, connect the supplied DC power cable directly to the battery terminals. *Do not attempt to defeat or bypass the DC cable's fuse - it is there to protect you, your transceiver, and your vehicle's electrical system.*

Warning!

Never apply AC power to the power cable of the FT-7800R, nor DC voltage greater than 15.8 Volts. When replacing the fuse, only use a 15-A fast-blow type. Failure to observe these safety precautions will void the Limited Warranty on this product.

- ❑ Before connecting the transceiver, check the voltage at the battery terminals while revving the engine. If the voltage exceeds 15 Volts, adjust the vehicle's voltage regulator before proceeding with installation.
- ❑ Connect the **RED** power cable lead to the **POSITIVE (+)** battery terminal, and the **BLACK** power cable lead to the **NEGATIVE (-)** terminal. If you need to extend the power cable, use #12 AWG or larger insulated, stranded copper wire. Solder the splice connections carefully, and wrap the connections thoroughly with insulating electrical tape.
- ❑ Before connecting the cable to the transceiver, verify the voltage and polarity of the voltage at the transceiver end of the DC cable using a DC voltmeter. Now connect the transceiver to the DC cable.

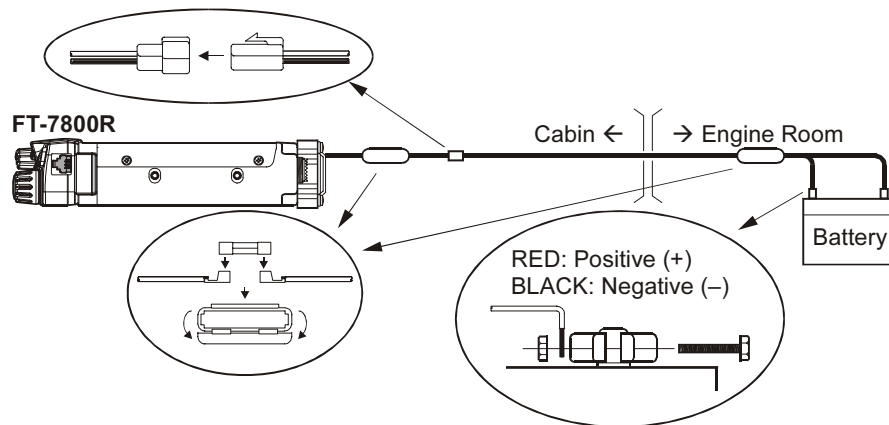

Mobile Speakers

The optional **MLS-100** External Speaker includes its own swivel-type mounting bracket, and is available from your Yaesu dealer.

Other external speakers may be used with the **FT-7800R**, if they present the specified 8-Ohm impedance and are capable of handling the 2 Watts of audio output supplied by the **FT-7800R**.

INSTALLATION

BASE STATION INSTALLATION

The **FT-7800R** is ideal for base station use as well as in mobile installations. The **FT-7800R** is specifically designed to integrate into your station easily, using the information to follow as a reference.

AC Power Supplies

Operation of the **FT-7800R** from an AC line requires a power source capable of providing at least 9 Amps continuously at 13.8 Volts DC. The **FP-1023** and **FP-1030A** AC Power Supplies are available from your Yaesu dealer to satisfy these requirements. Other well-regulated power supplies may be used, as well, if they meet the above voltage and current specifications.

Use the DC power cable supplied with your transceiver for making power connections to the power supply. Connect the **RED** power cable lead to the **POSITIVE (+)** power supply terminal, and connect the **BLACK** power cable lead to the **NEGATIVE (-)** power supply terminal.

Packet Radio Terminal Node Controller (TNC)

The **FT-7800R** provides a convenient rear-panel **DATA** jack for easy connections to your TNC. This connector is a standard mini-DIN connector. A pre-wired connector and cable assembly option, model **CT-39A**, is available from your local Yaesu dealer.

The **FT-7800R**'s **DATA** jack connections are optimized for the data transmission and reception speed in use. In accordance with industry standards, the signal levels, impedances, and bandwidths are significantly different on 9600 bps as opposed to 1200 bps. If your TNC does not provide multiple lines to accommodate such optimization, you may still be able to utilize your TNC, if it is designed for multiple-radio use, by connecting the TNC "Radio 1" port to the 1200 bps lines on the **FT-7800R**, and the "Radio 2" port to the 9600 bps lines.

The pin connections of the Data connector are shown below.

Pin	Label	Note	CT-39A Wire Color
1	PKD (DATA IN)	Packet Data Input <i>Impedance: 10 kΩ, Maximum Input Level: 40 mV p-p for 1200 bps 2.0 Vp-p for 9600 bps</i>	Brown
2	GND	Signal Ground	Red
3	PTT	Ground to Transmit	Orange
4	RX9600	9600 bps Packet Data Output <i>Impedance: 10 kΩ, Maximum Output: 500 mV p-p</i>	Yellow
5	RX1200	1200 bps Packet Data Output <i>Impedance: 10 kΩ, Maximum Output: 300 mV p-p</i>	Green
6	PKS (SQL)	Squelch Control <i>Squelch Open: +5 V, Squelch Close: 0 V</i>	Blue

INSTALLATION

BASE STATION INSTALLATION

Note that 9600 bps packet transmit-deviation adjustment is very critical to successful operation, and can only be accomplished using a calibrated deviation meter (such as that found on an FM Service Monitor used in a communications service center). In most cases, the Packet Data Input level (set via a potentiometer inside the TNC) must be adjusted to provide a deviation of ± 2.75 kHz (± 0.25 kHz). Check with your packet node's sysop if you have any questions about the appropriate deviation level for your network. Note also that high throughput on 9600 bps frequently requires strong signals, so you may wish to consider the use of a directional antenna such as a Yagi for communication with high-speed packet nodes.

The setting of the 1200 bps Packet Data Input level is much less critical than it is at 9600 bps, and satisfactory adjustment to the optimum ($\pm 2.5 \sim \pm 3.5$ kHz) deviation can usually be done "by ear" by adjusting the TNC's 1200 bps TX Audio Level potentiometer so that the outgoing packets (as monitored on a separate VHF or UHF receiver) are approximately the same level as (A) the DTMF tones or (B) the 1750 Hz Burst tone produced using the microphone.

Finally, note that the Menu ("Set") mode allows you to set the Packet data rate (1200 or 9600 bps) independently for each band. If you have trouble getting your **FT-7800R** to respond correctly during packet operation, check to be certain that you do not have Menu #26 (PKT.SPD) set to the wrong data rate.

You may activate the microphone input while operating on the packet mode via the Menu #25 (PKT.MIC), if desired. Generally, we do not recommend this, as a "live" microphone's audio input will tend to reduce throughput by interfering with the packets being transmitted by your radio.

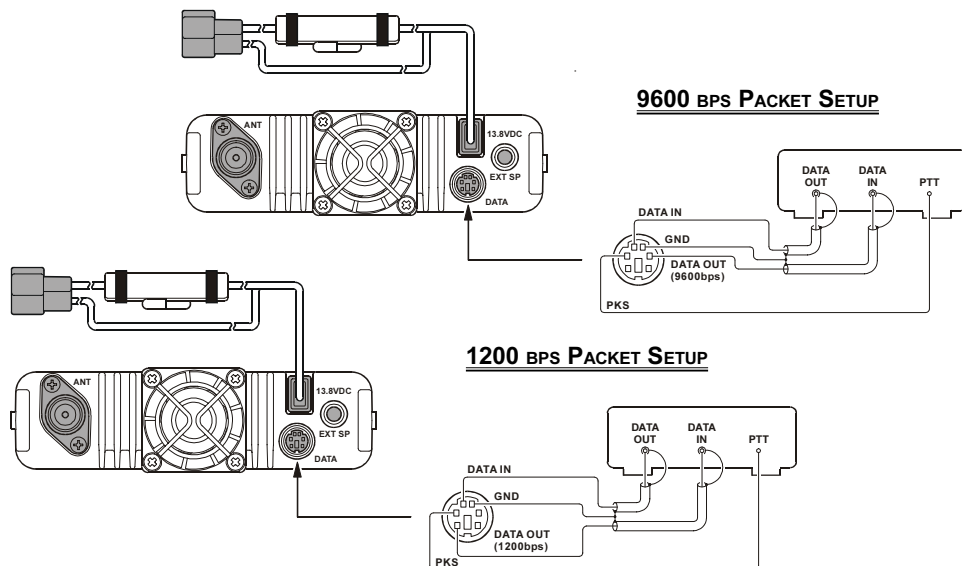

FRONT PANEL CONTROLS & SWITCHES

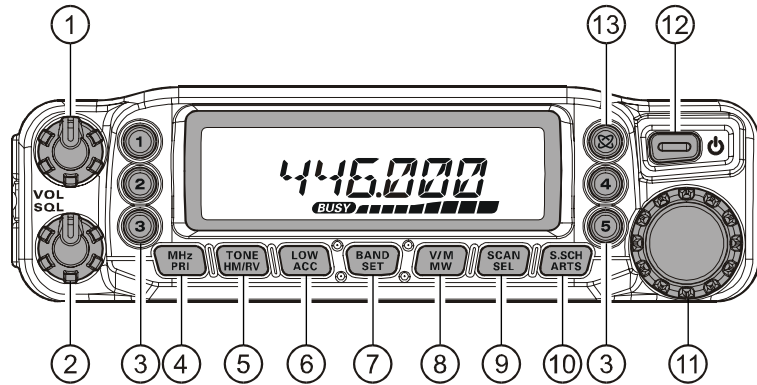

- ① **VOL Knob**

This control adjusts the volume level of the receiver's audio. Clockwise rotation increases the audio level.
- ② **SQL Knob**

This control sets the threshold level at which received signals (or noise) will open the squelch. It should be advanced clockwise just to the point where the noise is silenced (and the "**BUSY**" indicator on the display turns off), so as to provide the best sensitivity to weak signals.
- ③ **Hyper Memory Buttons ([1] ~ [5])**

Press and hold in one of these buttons for 2 seconds to store the current total configuration of the radio into a special "Hyper" memory bank.
Press the appropriate button momentarily to recall the desired "Hyper" memory.
- ④ **[MHZ(PRI)] Key**

Press this key momentarily to allow tuning in 1-MHz steps on the VFO frequency while operating on the VFO mode. In the Memory mode, press this key momentarily to allow tuning in 10 channel steps on the memory channels.
Press and hold in this key for 1/2 second to activate the Priority Channel Scanning (Dual Watch feature).
- ⑤ **[TONE(HM/RV)] Key**

Press this key momentarily to change the Tone Squelch mode: ENC (CTCSS Encoder), ENC.DEC (CTCSS Tone Squelch), or DCS (DCS) operation.
Press and hold in this key for 1/2 second to reverse the transmit and receive frequencies during split-frequency (i.e. "Repeater") operation.

FRONT PANEL CONTROLS & SWITCHES

- ⑥ [**LOW(ACC)**] Key
Press this key momentarily to select the transmitter power output level (“LOW,” “MID2,” “MID1,” or “HIGH”).
Press and hold in this key for 1/2 second to recall the Weather Broadcast Channels.
You can program the alternate (press and hold in) function of this key to another function, if desired. See page 60 for details.
- ⑦ [**BAND(SET)**] Key
While operating on the VFO mode, press this key momentarily to toggle the operating band as follows:
144 MHz → 250 MHz → 350 MHz → 430 MHz → 850 MHz → 144 MHz
In the Memory mode, press this key momentarily to activate the “Memory Tune” function.
Press and hold in this key for 1/2 second to enter the Set (“Menu”) mode.
- ⑧ [**V/M(MW)**] Key
Press this key momentarily to switch the frequency control among the VFO, Memory System, and Home channel.
Press and hold in this key for 1/2 second to transfer the VFO contents into a Memory register.
- ⑨ [**SCAN(SEL)**] Key
Press this key momentarily to activate the Scanner.
Press and hold in this key for 1/2 second to select the scan mode.
- ⑩ [**S.SCH(ARTS)**] Keys
Press this key momentarily to activate the Smart Search feature.
Press and hold in this key for 1/2 second to activate the ARTS feature.
- ⑪ **DIAL** knob
This 20-position detented rotary switch is the tuning dial for the transceiver. It is used for most tuning, memory selection, and function setting tasks on the transceiver.
- ⑫ **PWR** (⏻) Switch
Press and hold in this switch for 1/2 second to toggle the transceiver’s power on and off.
- ⑬ [**⊗**] Key
Press this key momentarily to activate the Internet Connection Feature.
Press and hold in this key for 1/2 second to indicate access number of the Internet Connection Feature.

SIDE PANEL CONNECTION & KNOB

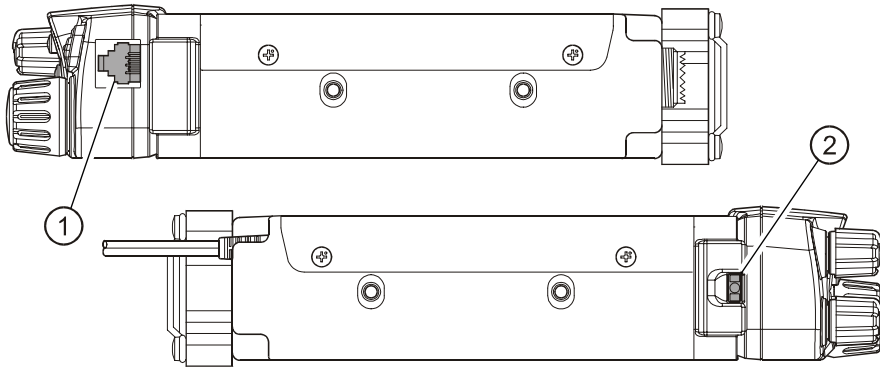

① MIC Jack (Right Side)

Connect the supplied microphone to this jack.

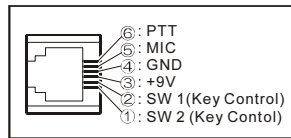

② Front Panel Release Knob (Left Side)

Press this knob to unlock the front panel to detachable the front panel from the transceiver's main body for remote-head operation (requires optional **YSK-7800** Separation Kit).

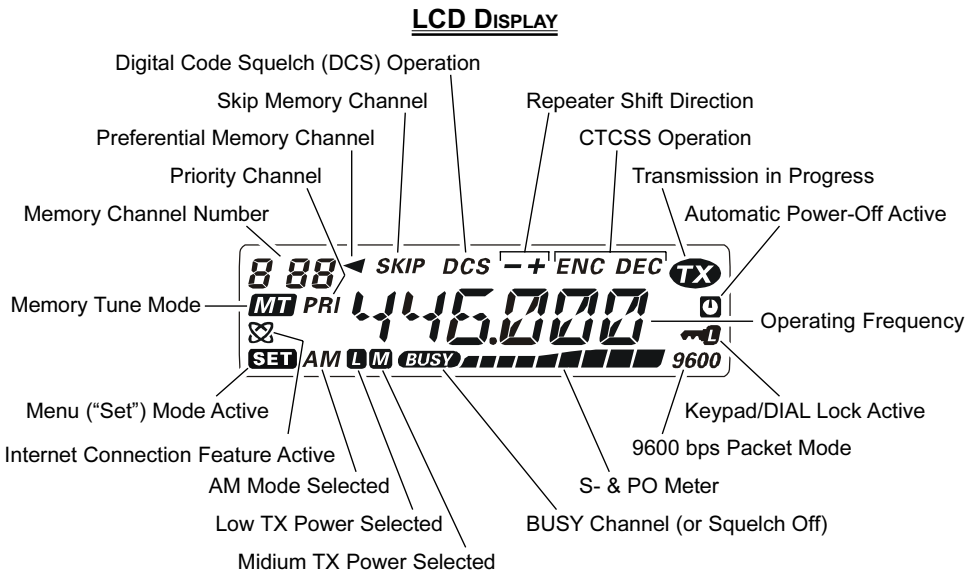

REAR PANEL CONNECTIONS

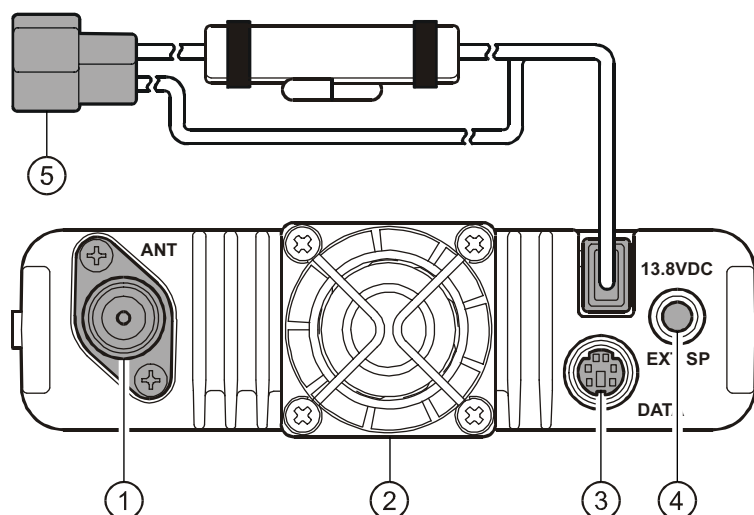

- ① **ANT Jack**
Connect your antenna here, using a type-M (PL-259) plug and coaxial cable.
- ② **Cooling Fan**
The cooling fan rotates during transmission, and for 30 seconds after the radio returns to the receive mode after transmitting.
When the RF power amplifier's heat sink reaches a moderately high temperature, the cooling fan will rotate automatically even if the radio is in the receive mode.
- ③ **DATA Jack**
This 6-pin mini-DIN connector provides simple interfacing to a packet Terminal Node Controller (TNC) for 1200 bps or 9600 bps operation. The pin connections are shown on page 10.
- ④ **EXT SP Jack**
This 2-conductor, 3.5-mm mini phone jack provides audio output for an optional speaker. The optimum load impedance is 8 Ohms. Inserting a plug into this jack disables the audio path to the transceiver's internal speaker.
- ⑤ **13.8V DC Cable Pigtails w/Fuse**
This is the DC power supply connection for the transceiver. Use the supplied DC cable to connect this pigtail to the car battery or base station DC power supply capable of at least 9 Amperes (continuous duty). Make certain that the Red lead connects to the Positive (+) side of the power source, and that the Black lead connects to the Negative (-) side of the power source.

MH-48A6J MICROPHONE

① PTT Switch

Press this switch to transmit, and release it to receive.

② Keypad

These 16 keys generate DTMF tones during transmission.

In the receive mode, the numeric (0 - 9) keys can be used for direct frequency entry and/or direct numeric recall of the Memory channels and the alphabet (A - D) keys can be used for controls the transceiver, as follow:

[A] Key:

Press this key momentarily to activate the Smart Search feature.

Press and hold in this key for 1/2 second to activates the ARTS feature.

[B] Key:

Press this key momentarily to switch the Memory Channel display between the "Frequency" format and "Alpha-numeric Tag" format.

[C] Key:

Press this key momentarily to disable the noise squelch action, allowing you to hear very weak signals near the background noise level.

[D] Key:

Press this key momentarily to allow tuning in 1-MHz steps on the VFO frequency while operating on the VFO mode. In the Memory mode, this allows tuning in 10-channel steps on the memory channels.

Press and hold in this key for 1/2 second to activate the Priority Channel Scanning (Dual Watch) feature.

③ [P1]/[P2]/[P3]/[P4] Buttons

[P1] button:

This button replicates the functions of the front panel [BAND(SET)] key.

While operating on the VFO mode, press this button momentarily to toggle the operating band as follows:

144 MHz → 250 MHz → 350 MHz → 430 MHz → 850 MHz → 144 MHz

In the Memory mode, press this button momentarily to activate the "Memory Tune" function.

Press and hold in this key for 1/2 second to enter the Set ("Menu") mode.

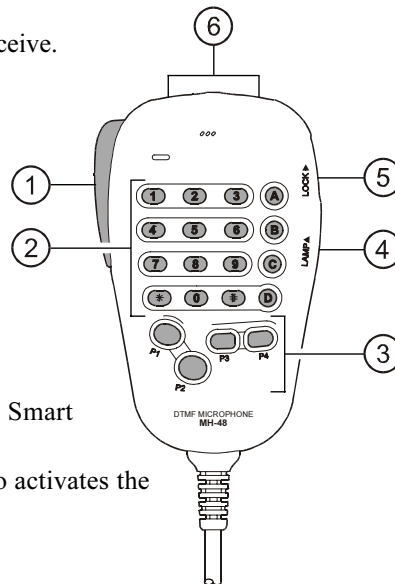

MH-48A6J MICROPHONE

[P2] button:

This button replicates the functions of the front panel **[V/M(MW)]** key.

Press this button momentarily to switch the frequency control among the VFO, Memory System, and Home channel.

Press and hold in this button for 1/2 second to transfer the VFO contents into a Memory register.

[P3] button:

This button replicates the functions of the front panel **[TONE(REV)]** key.

Press this button momentarily to change the Tone Squelch mode: ENC (CTCSS Encoder), ENC.DEC (CTCSS Tone Squelch), or DCS (DCS) operation.

Press and hold in this key for 1/2 second to reverse the transmit and receive frequencies during split-frequency (i.e. "Repeater") operation.

[P4] button:

This button replicates the functions of the front panel **[LOW(ACC)]** key.

Press this button momentarily to select the transmitter power output level ("LOW," "MID2," MID1," or "HIGH").

Press and hold in this key for 1/2 second to recall the Weather Broadcast Channels.

You can program the **[P1]**, **[P2]**, **[P3]**, and **[P4]** buttons for other functions, if desired. See page 60 for details.

④ **LAMP** Switch

This switch illuminates the Microphone's keypad.

⑤ **LOCK** Switch

This switch locks out the Microphone's buttons (except for the keypad and **PTT** switch).

⑥ **[UP]/[DWN]** Button

Press (or hold in) either of these buttons to tune (or scan up or down) the operating frequency or through the memory channels. In many ways, these buttons emulate the function of the (rotary) **DIAL** knob.

MH-42B6JS MICROPHONE

The optional **MH-42B6JS** is similar to the **MH-48A6J**, but the **MH-42B6JS** does not include a DTMF keypad and its illumination switch.

① **PTT Switch**

Press this switch to transmit, and release it to receive.

②. **[ACC]/[P]/[P1]/[P2] Buttons**

[ACC] button:

This button replicates the functions of the front panel **[BAND(SET)]** key.

While operating on the VFO mode, press this button momentarily to toggle the operating band as follows:

144 MHz → 250 MHz → 350 MHz →
430 MHz → 850 MHz → 144 MHz

In the Memory mode, press this button momentarily to activate the “Memory Tune” function.

Press and hold in this key for 1/2 second to enter the Set (“Menu”) mode.

[P] button:

This button replicates the functions of the front panel **[V/M(MW)]** key.

Press this button momentarily to switch the frequency control among the VFO, Memory System, and Home channel.

Press and hold in this button for 1/2 second to transfer the VFO contents into a Memory register.

[P1] button:

This button replicates the functions of the front panel **[TONE(REV)]** key.

Press this button momentarily to change the Tone Squelch mode: ENC (CTCSS Encoder), ENC.DEC (CTCSS Tone Squelch), or DCS (DCS) operation.

Press and hold in this key for 1/2 second to reverse the transmit and receive frequencies during split-frequency (i.e. “Repeater”) operation.

[P2] button:

This button replicates the functions of the front panel **[LOW(ACC)]** key.

Press this button momentarily to select the transmitter power output level (“LOW,” “MID2,” “MID1,” or “HIGH”).

Press and hold in this key for 1/2 second to recall the Weather Broadcast Channels.

You can program the **[ACC]**, **[P]**, **[P1]**, and **[P2]** buttons for other functions, if desired. See page 60 for details.

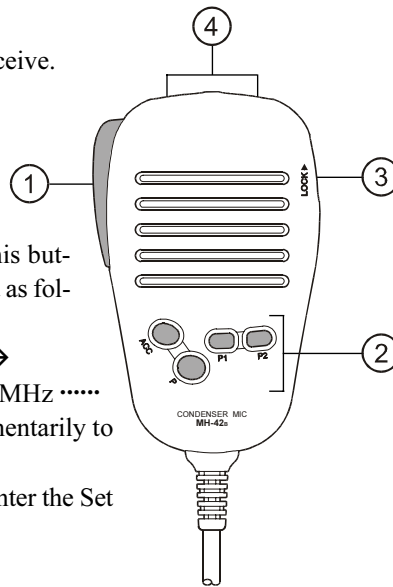

MH-42B6JS MICROPHONE

③. **LOCK** Switch

This switch locks out the Microphone's buttons (except for the **PTT** switch).

④. **[UP]/[DWN]** Button

Press (or hold in) either of these buttons to tune (or scan up or down) the operating frequency or through the memory channels. In many ways, these buttons emulate the function of the (rotary) **DIAL** knob.

Notice: If you change the microphone from the **MH-48A6J** to the **MH-42B6JS** or vice versa, change the setting of Menu #22 (MIC). See page 71 for details.

BASIC OPERATION



Hi! I'm R. F. Radio, and I'll be helping you along as you learn the many features of the FT-7800R. I know you're anxious to get on the air, but I encourage you to read the "Operation" section of this manual as thoroughly as possible, so you'll get the most out of this fantastic new transceiver. Now. . .let's get operating!

TURNING THE TRANSCEIVER ON AND OFF

1. To turn the transceiver on, press and hold in the **PWR** (⏻) switch for 1/2 second.
When you turn on the **FT-7800R**, the current DC supply voltage is indicated on the LCD for 2 seconds. After this interval, the display will switch its normal indication of the operating frequency.
2. To turn the transceiver off, again press and hold in the **PWR** (⏻) switch for 1/2 second.

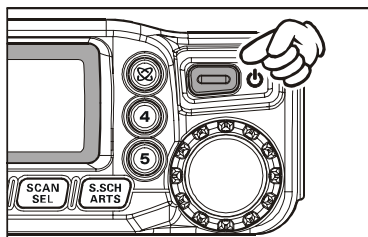

ADJUSTING THE AUDIO VOLUME LEVEL AND SQUELCH SETTING

At first, set the **SQL** knob fully counter-clockwise. Now, you may rotate the **VOL** knob clockwise to adjust the receiver volume for a comfortable listening level, using the background noise as a reference.

To set the squelch, turn the **SQL** knob clockwise a slightly past the point where the background noise is muted. This is the point of best sensitivity to weak signals, and we recommend that you not rotate the **SQL** knob very much past the point where the background noise is just silenced.

A special "RF Squelch" feature is provided on this radio. This feature allows you to set the squelch so that only signals exceeding a certain S-meter level will open the squelch. See page 24 for details

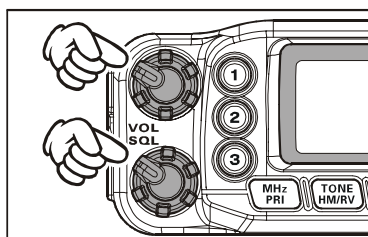

SELECTING THE OPERATING BAND

Press the [**BAND(SET)**] key to move the operating band:

144 MHz → 250 MHz → 350 MHz →
430 MHz → 850 MHz → 144 MHz



You may select the operating band by pressing the microphone's [**PI**] key.

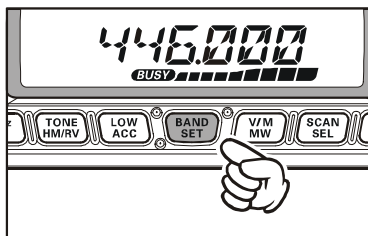

BASIC OPERATION

FREQUENCY NAVIGATION

1) Tuning Dial

Rotating the **DIAL** knob allows tuning in the pre-programmed steps established for the VFO frequency. Clockwise rotation of the **DIAL** knob causes the **FT-7800R** to be tuned toward a higher frequency, while counter-clockwise rotation will lower the operating frequency.

Press the [**MHz(PRI)**] key momentarily, then rotate the **DIAL** knob, to change the frequency steps to 1 MHz per step. This feature is extremely useful for making rapid frequency excursions over the wide tuning range of the **FT-7800R**.

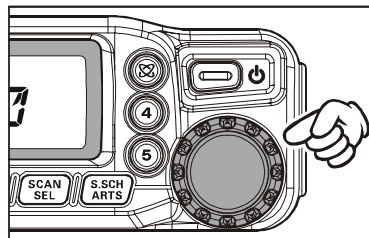

2) Direct Keypad Frequency Entry (MH-48A6J Microphone)

The keypad of the **MH-48A6J** DTMF Microphone may be used for direct entry of the operating frequency.

To enter a frequency from the **MH-48A6J** keypad, just press the numbered digits in the proper sequence. There is no “Decimal point” key on the **MH-48A6J** keypad.

Examples: To enter 146.480 MHz, press [1] → [4] → [6] → [4] → [8] → [0]

To enter 433.000 MHz, press [4] → [3] → [3] → [0] → [0] → [0]

3) Scanning

From the VFO mode, press and hold in the [**SCAN(SEL)**] key for 1/2 second, then rotate the **DIAL** knob to select the bandwidth for the VFO scanner. Now, press the [**SCAN(SEL)**] key momentarily to initiate scanning toward a higher frequency. The **FT-7800R** will stop when it receives a signal strong enough to break through the squelch threshold. The **FT-7800R** will then hold on that frequency according to the setting of the “Resume” mode (Menu #37 (SCAN); see page 73). See page 41 for details regarding the VFO Scan operation.

If you wish to reverse the direction of the scan (i.e. toward a lower frequency, instead of a higher frequency), just rotate the **DIAL** knob one click in the counter-clockwise direction while the **FT-7800R** is scanning. The scanning direction will be reversed. To revert to scanning toward a higher frequency once more, rotate the **DIAL** knob one click clockwise.

Press the [**SCAN(SEL)**] key (or the **PTT** key) again to stop scanning.





You may also initiate the scanner by pressing and holding in the microphone's [UP] or [DWN] key. However, in this case, the scanner will sweep frequencies only on the current band. If you would like the scanner not to be restricted to the current band, you may change Menu #46 (VFO.BND) to allow the scanner to hop to the low edge of the next-highest band when the VFO frequency reaches the high end of the current band (or vice-versa). See page 75 for details.

BASIC OPERATION

TRANSMISSION

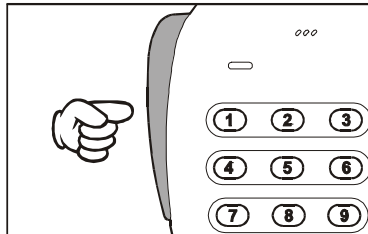
To transmit, simply close the **PTT** (Push To Talk) switch on the microphone when the frequency is clear. Hold the microphone approximately 25 mm (1") from your mouth, and speak into the microphone in a normal voice level. When your transmission is complete, release the **PTT** switch; the transceiver will revert to the receive mode.



 *When the RF power amplifier heat sink rises to a factory preset temperature, the transmit power level will be reduced to the “LOW” setting automatically to prevent over-heating of the radio. If you leave transmit in this condition (even in the “LOW” mode) for an extended period of time, the radio will be forced to return to the receive mode.*

Changing the Transmitter Power Level

You can select from among a total of four transmit power levels on your **FT-7800R**.

To change the power level, press the [**LOW(ACC)**] key to select one of four power settings. These power levels will be stored, in memory registers, at the time of memory storage (see page 32 for details on Memory operation).

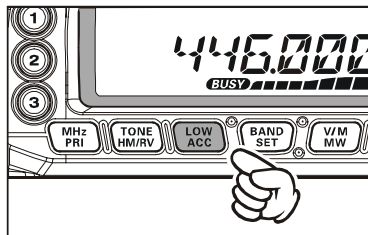

During transmission, the Bar Graph will deflect in the display, according to the power output selected.



"LOW" POWER (5 W)



"MID 2" POWER (10 W)



"MID 1" POWER (20 W)



"HIGH" POWER (50 W: 144 MHz, 40 W: 430 MHz)

ADVANCED OPERATION

LOCK FEATURE

In order to prevent accidental frequency change or inadvertent transmission, various aspects of the **FT-7800R**'s keys may be locked out. The possible lockout combinations are:

- LK KEY: Just the front panel keys and microphone buttons are locked out (except for the **PTT** switch).
- LK DIAL: Just the front panel **DIAL** is locked out.
- LK K+D: Both the **DIAL** and keys (include microphone buttons) are locked out.
- LK PTT: The **PTT** switch is locked (TX not possible).
- LK P+K: Both the keys (include microphone buttons) and **PTT** switch are locked out.
- LK P+D: Both the **PTT** switch and **DIAL** are locked out.
- LK ALL: All of the above are locked out.
- LK OFF: The Lock feature is disabled.

To lock out some or all of the keys:

1. Press and hold in the [**BAND(SET)**] key for 1/2 second to enter the Set (Menu) mode.
2. Rotate the **DIAL** knob to select Menu #21 (LOCK).
3. Press the [**BAND(SET)**] key momentarily, then rotate the **DIAL** knob to choose between one of the locking schemes as outline above.
4. When you have made your selection, press the [**BAND(SET)**] key momentarily to save the new setting, then press and hold in the [**BAND(SET)**] key for 1/2 second to exit to normal operation.
5. To unlock the panel switches and **DIAL** knobs, select "LK OFF" in step 3 above.



The LCD display shows the number '21' in the top left corner, followed by the word 'LOCK' in large characters. A small 'SET' indicator is visible in the bottom left corner.

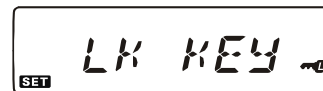

The LCD display shows the text 'LK KEY' in large characters. A small 'SET' indicator is visible in the bottom left corner.



The LCD display shows the frequency '446.000' in large characters. Below the frequency is a 'BUSY' indicator consisting of a series of small squares. A small 'SET' indicator is visible in the bottom left corner.

KEYBOARD BEEPER

A key/button beeper provides useful audible feedback whenever a key/button is pressed.

If you want to turn the beep off:

1. Press and hold in the [**BAND(SET)**] key for 1/2 second to enter the Set mode.
2. Rotate the **DIAL** knob to select Menu #5 (BEEP).
3. Press the [**BAND(SET)**] key momentarily, then rotate the **DIAL** knob to change the setting to "OFF."
4. Press the [**BAND(SET)**] key momentarily to save the new setting, then press and hold in the [**BAND(SET)**] key for 1/2 second to exit to normal operation.
5. To turn the beep back on again, select "KEY" or "KEY+SC (default)" in step 3 above.
 - KEY: The beeper sounds when you press any key.
 - KEY+SC: The beeper sounds when you press a key, or when the scanner stops.



The LCD display shows the number '5' in the top left corner, followed by the word 'BEEP' in large characters. A small 'SET' indicator is visible in the bottom left corner.



The LCD display shows the text 'BEEP OFF' in large characters. A small 'SET' indicator is visible in the bottom left corner.

ADVANCED OPERATION

DISPLAY BRIGHTNESS

The **FT-7800R** display illumination has been specially engineered to provide high visibility with minimal disruption of your “night vision” while you are driving. The brightness of the display is manually adjustable, using the following procedure:

1. Press and hold in the [**BAND(SET)**] key for 1/2 second to enter the Set mode.
2. Rotate the **DIAL** knob to select Menu #11 (DIMMER).
3. Press the [**BAND(SET)**] key momentarily, then rotate the **DIAL** knob to select a comfortable brightness level: DIM 1, DIM 2, DIM 3, or DIM.OFF (no illumination).
4. Press the [**BAND(SET)**] key momentarily to save the new setting, then press and hold in the [**BAND(SET)**] key for 1/2 second to exit to normal operation.



The display shows the number "11" in the top left corner, followed by the word "DIMMER" in a large, stylized font. A small "SET" indicator is visible in the bottom left corner of the display area.



The display shows the word "DIM" followed by the number "1" in a large, stylized font. A small "SET" indicator is visible in the bottom left corner of the display area.

RF SQUELCH

A special “RF Squelch” feature is provided on this radio. This feature allows you to set the squelch so that only signals exceeding a certain S-meter level will open the squelch.

To set up the RF Squelch circuit for operation, use the following procedure:

1. Press and hold in the [**BAND(SET)**] key for 1/2 second to enter the Set mode.
2. Rotate the **DIAL** knob to select Menu #32 (RF SQL).
3. Press the [**BAND(SET)**] key momentarily, then rotate the **DIAL** knob to select the desired signal strength level for the squelch threshold (OFF, S-2, S-3, S-4, S-5, S-6, S-7, S-8, S-9, or S-FULL).
4. Press the [**BAND(SET)**] key momentarily to save the new setting, then press and hold in the [**BAND(SET)**] key for 1/2 second to exit to normal operation.
5. Finally, rotate the **SQL** knob fully clockwise.

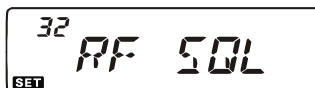

The display shows the number "32" in the top left corner, followed by the words "RF SQL" in a large, stylized font. A small "SET" indicator is visible in the bottom left corner of the display area.



The display shows the signal strength level "S-9" in a large, stylized font. A small "SET" indicator is visible in the bottom left corner of the display area.

ADVANCED OPERATION

CHANNEL STEP SELECTION

The **FT-7800R**'s synthesizer provides the option of utilizing channel steps of 5/10/12.5/15/20/25/50/100 kHz per step, as well as an automatic step selection based on the current operating frequency ("AUTO"), any number of which may be important to your operating requirements. The **FT-7800R** is set up at the factory in the "AUTO" configuration, which probably is satisfactory for most operation. However, if you need to change the channel step increments, the procedure to do so is very easy; remember to get set up on the desired band before making any changes, as different steps may be programmed for each operating band.

1. Press and hold in the **[BAND(SET)]** key for 1/2 second to enter the Set mode.
2. Rotate the **DIAL** knob to select Menu #43 (STEP).
3. Press the **[BAND(SET)]** key momentarily, then rotate the **DIAL** knob to select the new channel step size.
4. Press the **[BAND(SET)]** key momentarily to save the new setting, then press and hold in the **[BAND(SET)]** key for 1/2 second to exit to normal operation.



5 kHz and 15 kHz steps are not available for use on above 700 MHz.

RECEIVING MODE SELECTION

The **FT-7800R** provides for automatic mode change when the radio is tuned to different operating frequencies. However, should an unusual receiving situation arise in which you need to change to other receiving mode, the procedure to do so is very easy.

1. Press and hold in the **[BAND(SET)]** key for 1/2 second to enter the Set mode.
2. Rotate the **DIAL** knob to select Menu #35 (RX MOD).
3. Press the **[BAND(SET)]** key momentarily, then rotate the **DIAL** knob to select the desired receiving mode.
 - AUTO: Automatic mode setting per default values for the selected frequency range
 - FM: Frequency Modulation (Narrow FM)
 - AM: Amplitude Modulation
4. Press the **[BAND(SET)]** key momentarily to save the new setting, then press and hold in the **[BAND(SET)]** key for 1/2 second to exit to normal operation.

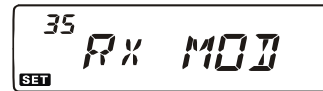

Unless you have a compelling reason to do so, leave the Automatic Mode Selection feature on so as to save time and trouble when changing bands. If you make a mode change for a particular channel or station, you can always store that one channel into memory, as the mode setting will be memorized along with the frequency information.

REPEATER OPERATION

Repeater stations, usually located on mountaintops or other high locations, provide a dramatic extension of the communication range for low-powered hand-held or mobile transceivers. The **FT-7800R** includes a number of features which make repeater operation simple and enjoyable.

REPEATER SHIFTS

Your **FT-7800R** has been configured, at the factory, for the repeater shifts customary in your country. While the 144 MHz shift will be 600 kHz; on 70 cm, the shift may be 1.6 MHz, 7.6 MHz, or 5 MHz (USA version).

Depending on the part of the band in which you are operating, the repeater shift may be either downward (–) or upward (+), and one of these icons will appear at the top of the LCD when repeater shifts have been enabled.

AUTOMATIC REPEATER SHIFT (ARS)

The **FT-7800R** provides a convenient Automatic Repeater Shift feature, which causes the appropriate repeater shift to be automatically applied whenever you tune into the designated repeater sub-bands in your country. These sub-bands are shown below.

If the ARS feature does not appear to be working, you may have accidentally disabled it.

To re-enable ARS:

1. Press and hold in the [**BAND(SET)**] key for 1/2 second to enter the Set mode.
2. Rotate the **DIAL** knob to select Menu #4 (ARS).
3. Press the [**BAND(SET)**] key momentarily, then rotate the **DIAL** knob to change the setting to “ON” (to enable Automatic Repeater Shift).
4. Press the [**BAND(SET)**] key momentarily to save the new setting, then press and hold in the [**BAND(SET)**] key for 1/2 second to exit to normal operation.



With repeater shift activated, you can temporarily reverse the transmit and receive frequencies by pressing and holding in the [**TONE(HM/RV)**] key for 1/2 second. Use this feature to display the transmit frequency *without transmitting*, and to check the strength of signals on a repeater uplink frequency (so as to determine whether of not a particular station is within “Simplex” range, for example).

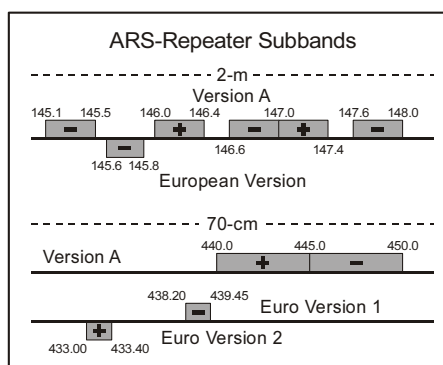

REPEATER OPERATION

MANUAL REPEATER SHIFT ACTIVATION

If the ARS feature has been disabled, or if you need to set a repeater shift direction other than that established by the ARS, you may set the direction of the repeater shift manually.

To do this:

1. Press and hold in the [**BAND(SET)**] key for 1/2 second to enter the Set mode.
2. Rotate the **DIAL** knob to select Menu #33 (RPT.MOD).
3. Press the [**BAND(SET)**] key momentarily, then rotate the **DIAL** knob to select the desired shift among “RPT.-,” “RPT.+,” and “RPT.OFF.”
4. Press the [**BAND(SET)**] key momentarily to save the new setting, then press and hold in the [**BAND(SET)**] key for 1/2 second to exit to normal operation.

Changing the Default Repeater Shifts

If you travel to a different region, you may need to change the default repeater shift so as to ensure compatibility with local operating requirements.

To do this, follow the procedure below:

1. Press and hold in the [**BAND(SET)**] key for 1/2 second to enter the Set mode.
2. Rotate the **DIAL** knob to select Menu #39 (SHIFT).
3. Press the [**BAND(SET)**] key momentarily, then rotate the **DIAL** knob to select the new repeater shift magnitude. The shift must be a multiple of 50 kHz.
4. Press the [**BAND(SET)**] key momentarily to save the new setting, then press and hold in the [**BAND(SET)**] key for 1/2 second to exit to normal operation.



If you just have one “odd” split that you need to program, don’t change the “default” repeated shifts using this Menu Item! Enter the transmit and receive frequencies separately, as shown on page 33.

CTCSS/DCS OPERATION

CTCSS OPERATION

Many repeater systems require that a very-low-frequency audio tone be superimposed on your FM carrier in order to activate the repeater. This helps prevent false activation of the repeater by radar or spurious signals from other transmitters. This tone system, called “CTCSS” (Continuous Tone Coded Squelch System), is included in your **FT-7800R**, and is very easy to activate.

 **CTCSS setup involves two actions: setting the Tone Mode and then setting of the Tone Frequency. These actions are set up by using the [TONE(REV)] key and Set mode #44 (TN FRQ).**

1. Press the [TONE(REV)] key several times, so that “ENC” appears on the display; this activates the CTCSS Encoder, which allows repeater access.



 **1) You may notice an additional “DCS” icon appearing while you press the [TONE(REV)] key in this step. We’ll discuss the Digital Code Squelch system shortly.**

2) You may notice the “REV TN” indication on the display; this means that the Reverse Tone Squelch system is active, which mutes your FT-7800R’s receiver when it receives a call from the radio sending a matched CTCSS tone. The “DEC” icon will blink on the display when the Reverse Tone Squelch system is activated.

2. Pressing the [TONE(REV)] key once more in above step will cause “ENC DEC” to appear. When “ENC DEC” appears, this means that the Tone Squelch system is active, which mutes your **FT-7800R**’s receiver until it receives a call from another radio sending out a matching CTCSS tone. This can help keep your radio quiet until a specific call is received, which may be helpful while operating in congested areas.



3. When you have made your selection of the CTCSS tone mode, press and hold in the [BAND(SET)] key for 1/2 second to enter the Set mode, then rotate the **DIAL** knob to select Menu #44 (TN FRQ). This Menu selection allows setting of the CTCSS tone frequency to be used.

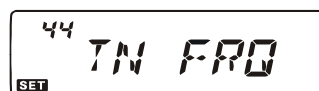

4. Press the [BAND(SET)] key momentarily to enable adjustment of the CTCSS frequency.

5. Rotate the **DIAL** knob until the display indicates the Tone Frequency you need to be using.



CTCSS TONE FREQUENCY (Hz)					
67.0	69.3	71.9	74.4	77.0	79.7
82.5	85.4	88.5	91.5	94.8	97.4
100.0	103.5	107.2	110.9	114.8	118.8
123.0	127.3	131.8	136.5	141.3	146.2
151.4	156.7	159.8	162.2	165.5	167.9
171.3	173.8	177.3	179.9	183.5	186.2
189.9	192.8	196.6	199.5	203.5	206.5
210.7	218.1	225.7	229.1	233.6	241.8
250.3	254.1	—	—	—	—

6. When you have made your selection, press

CTCSS/DCS OPERATION

CTCSS OPERATION

the [BAND(SET)] key momentarily to save the new setting, then press and hold in the [BAND(SET)] key for 1/2 second to exit to normal operation.

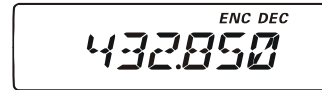

 *Your repeater may or may not re-transmit a CTCSS tone - some systems just use CTCSS to control access to the repeater, but don't pass it along when transmitting. If the S-Meter deflects, but the FT-7800R is not passing audio, press the [TONE(REV)] key so that "ENC" appears - this will allow you to hear all traffic on the channel being received.*

DCS OPERATION

Another form of tone access control is Digital Code Squelch, or DCS. It is a newer, more advanced tone system which generally provides more immunity from false paging than does CTCSS. The DCS Encoder/Decoder is built into your **FT-7800R**, and operation is very similar to that just described for CTCSS. Your repeater system may be configured for DCS; if not, it is frequently quite useful in Simplex operation if your friend(s) use transceivers equipped with this advanced feature.

 *Just as in CTCSS operation, DCS requires that you set the Tone Mode to DCS and that you select a Tone Code.*

1. Press the [TONE(REV)] key until "DCS" appears on the display; this activates the DCS Encoder/Decoder.
2. Now, press and hold in the [BAND(SET)] key for 1/2 second to enter the Set mode, then rotate the DIAL knob to select Menu #9 (DCS.COD).
3. Press the [BAND(SET)] key momentarily to enable the adjustment of the DCS code.
4. Rotate the DIAL knob to select the desired DCS Code (a three-digit number).
5. When you have made your selection, press the [BAND(SET)] key momentarily to save the new setting, then press and hold in the [BAND(SET)] key for 1/2 second to exit to normal operation.

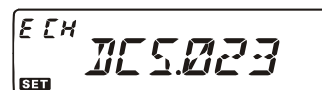
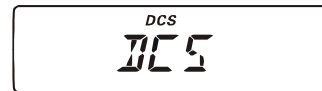

DCS CODE									
023	025	026	031	032	036	043	047	051	053
054	065	071	072	073	074	114	115	116	122
125	131	132	134	143	145	152	155	156	162
165	172	174	205	212	223	225	226	243	244
245	246	251	252	255	261	263	265	266	271
274	306	311	315	325	331	332	343	346	351
356	364	365	371	411	412	413	423	431	432
445	446	452	454	455	462	464	465	466	503
506	516	523	526	532	546	565	606	612	624
627	631	632	654	662	664	703	712	723	731
732	734	743	754	-	-	-	-	-	-

Remember that the DCS is an Encode/Decode system, so your receiver will remain muted until a matching DCS code is received on an incoming transmission. Switch the DCS off when you're just tuning around the band!

CTCSS/DCS OPERATION

TONE SEARCH SCANNING

In operating situations where you don't know the CTCSS or DCS tone being used by another station or stations, you can command the radio to listen to the incoming signal and scan in search of the tone being used. Two things must be remembered in this regard:

- You must be sure that your repeater uses the same tone type (CTCSS vs. DCS).
- Some repeaters do not pass the CTCSS tone; you may have to listen to the station(s) transmitting on the repeater uplink (input) frequency in order to allow Tone Search Scanning to work.

To scan for the tone in use:

1. Set the radio up for either CTCSS or DCS Decoder operation (see the previous discussion). In the case of CTCSS, "**ENC DEC**" will appear on the display; in the case of DCS, "**DCS**" will appear on the display.
2. Press and hold in the [**BAND(SET)**] key for 1/2 second to enter the Set mode.
3. Rotate the **DIAL** knob to select Menu #44 (TN FRQ) when CTCSS is selected, or Menu #9 (DCS.COD) during DCS operation.
4. Press the [**BAND(SET)**] key to enable adjustment of the selected Menu Item.
5. Press the [**SCAN(SEL)**] key momentarily to start scanning for the incoming CTCSS or DCS tone/code.
6. When the radio detects the correct tone or code, it will halt on that tone/code, and audio will be allowed to pass. Press the [**BAND(SET)**] key momentarily to lock in that tone/code, then press and hold in the [**BAND(SET)**] key for 1/2 second to save the new setting and exit to normal operation.

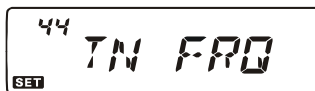

 *If the Tone Scan feature does not detect a tone or code, it will continue to scan indefinitely. When this happens, it may be that the other station is not sending any tone. You can press the [SCAN(SEL)] key to halt the scan at any time.*

Tone Scanning works either in the VFO or Memory modes.

CTCSS/DCS OPERATION

SPLIT TONE OPERATION

The **FT-7800R** can be operated in a Split Tone configuration via the Set mode.

1. Press and hold in the [**BAND(SET)**] key for 1/2 second to enter the Set mode.
2. Rotate the **DIAL** knob to select Menu #41 (SPLIT).
3. Press the [**BAND(SET)**] key momentarily, then rotate the **DIAL** knob to select “ON” (to enable the Split Tone feature).
4. Press the [**BAND(SET)**] key momentarily to save the new setting, then press and hold in the [**BAND(SET)**] key for 1/2 second to exit to normal operation.

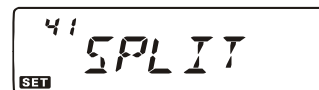

41 SPLIT



SPLIT ON

When the Split Tone feature is activated, you can see the following additional parameters after the “DCS” parameter while selecting the Tone Mode by pressing the [**TONE(REV)**] key:

- D: DCS Encode only
(the “**DCS**” icon will blink during operation)
- ENC DCS: Encodes a CTCSS Tone and Decodes a DCS code
(the “**DCS**” and “**ENC**” icons will appear during operation)
- D-DEC: Encodes a DCS code and Decodes a CTCSS Tone
(the “**DCS**” icon will blink and the “**DEC**” icon will appear during operation)

Select the desired operating mode, from the selections shown above.

MEMORY OPERATION

The **FT-7800R** provides a wide variety of memory system resources. These include:

- ❑ “Regular” Memory Channels, which includes:
 - 1000 “Standard” memory channels, numbered “000” through “999.”
 - 5 Home channels, providing storage and quick recall of one prime frequency on each operating band.
 - 50 sets of band-edge memories also known as “Programmable Memory Scan” channels, labeled “L1/U1” through “L50/U50.”
 - 20 Memory Banks, labeled “BANK1” through “BANK20.” Each Memory Bank can be assigned from the “Standard” Memory Channels.
- ❑ 5 “Hyper-Memory” Channels
- ❑ 10 “Weather Broadcast” Channels

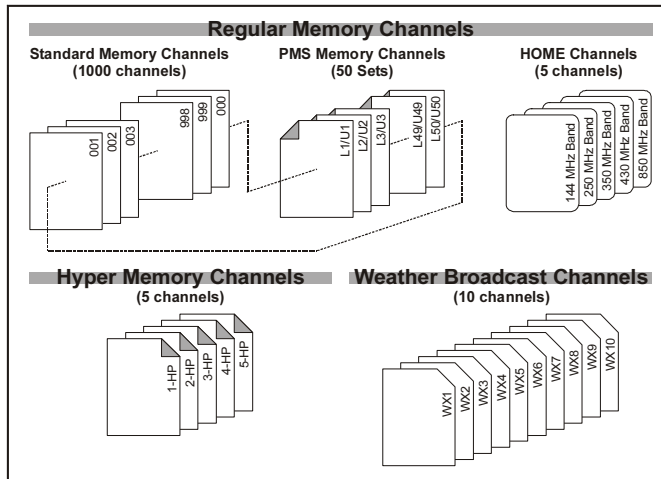

REGULAR MEMORY CHANNEL OPERATION

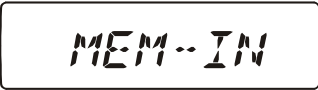

Memory Storage

1. Select the desired frequency, while operating in the VFO mode. Be sure set up any desired CTCSS or DCS tones, as well as any desired repeater offset. The power level may be also be set at this time, if you wish to store it.
2. Press and hold in the **[V/M(MW)]** key for 1/2 second. A memory number will appear (blinking) on the display. 
3. Within ten seconds of pressing the **[V/M(MW)]** key, use the **DIAL** knob or the microphone’s **[UP]/[DWN]** buttons to select the desired memory channel for storage (if the channel is already occupied by data stored previously, the “channel frequency” notation will appear on the display).
4. To attach an alpha/numeric name “Tag” to the memory, press and hold in the **[V/M(MW)]** key for 1/2 second, then proceed to the next step; otherwise press the **[V/M(MW)]** key momentarily to save the entry and exit to normal operation. 

MEMORY OPERATION

REGULAR MEMORY CHANNEL OPERATION

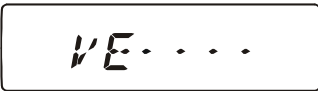
To Append an Alpha-numeric “Tag” to a Memory

1. After pressing and holding in the [V/M(MW)] key in step 4 above, rotate the **DIAL** knob to select the first character in the name you wish to store, then press the [BAND(SET)] key momentarily to move on to the next character. Letters, numbers, and symbols are available for storage.

2. Again rotate the **DIAL** knob to select the desired letter, number, or symbol, then press the [BAND(SET)] key momentarily to move on to the next character’s slot. If you make a mistake, press the microphone’s [DWN] button to move back to the previous character’s slot, then re-select the correct letter, number, or symbol.

3. Repeat the above step to program the remaining letters, numbers, or symbols of the desired label. A total of six characters may be used in the creation of a label.

4. When you have completed the creation of the label, press and hold in the [BAND(SET)] key for 1/2 second to save the label and exit to normal operation.

Storing Independent Transmit Frequencies (“Odd Splits”)

1. Store the receiving frequency using the method already described.
2. Turn to the desired transmit frequency, then press and hold in the [V/M(MW)] key for 1/2 second.
3. Within ten seconds of pressing the [V/M(MW)] key, use the **DIAL** knob or microphone’s [UP]/[DWN] buttons to select the same memory channel number as used in step 1 above.
4. Press and hold in the **PTT** switch, then pressing and holding the [V/M(MW)] key for 1/2 second while holding the **PTT** switch to save the entry and exit to normal operation. This will not cause transmission; instead, it signals the microprocessor that a separate *transmit* frequency is being programmed into that memory register.



 Whenever you recall a memory which contains independently-stored transmit and receive frequencies, the “- +” indication will appear in the display.



MEMORY OPERATION

REGULAR MEMORY CHANNEL OPERATION

Memory Recall

1. While operating in the VFO mode, press the [V/M(MW)] key momentarily to enter the Memory mode. 
2. Rotate the **DIAL** knob to select the desired channel. If you press the [MHz(PRI)] key momentarily, then rotate the **DIAL** knob, you'll be able to scroll through the memory channels at a rate of 10 channels per click of the **DIAL**.
3. When selecting a memory channel that has an alpha-numeric "Tag" (label) appended, press the microphone's [B] key momentarily to switch the Memory Channel display between the "Frequency" format and "Alpha-numeric Tag" format. 
4. To return to the VFO mode, press the [V/M(MW)] key momentarily again.



When the radio is already set to the Memory mode, an easy way to recall memories is to enter the microphone's key in the memory channel number. For example, to recall memory channel #4, press [0] → [0] → [4].

Memory Offset Tuning

Once you have recalled a particular memory channel, you may easily tune off that channel, as though you were in the "VFO" mode.

1. With the **FT-7800R** in the "MR" (Memory Recall) mode, select the desired memory channel.
2. Now press the [BAND(SET)] key momentarily; the "MT" icon will appear on the display. 
3. Rotate the **DIAL** knob, as desired, to tune to a new frequency. The synthesizer steps selected for VFO operation on the current band will be the steps used during Memory Tuning.
4. If you press and hold in the [SCAN(SEL)] key for 1/2 second during Memory Tuning, the data will now have been copied to VFO, although the original memory contents will remain intact on the previously-stored channel.
5. If you wish to return to the original memory frequency, press the [BAND(SET)] key momentarily. The "MT" icon will disappear.

MEMORY OPERATION

REGULAR MEMORY CHANNEL OPERATION

Deleting Memories

With 1000 “Regular” memories available (except memory channel “1”), there frequently are situations where you may desire to delete certain memorized frequencies. The procedure for deleting a channel is quite simple:

1. Press the [V/M(MW)] key, if needed, to enter the Memory mode.
2. Press and hold in the [V/M(MW)] key for 1/2 second, then rotate the **DIAL** knob to select the memory channel to be deleted. Note that memory channel “1” may not be deleted.
3. Press the [SCAN(SEL)] key momentarily. The display will revert to memory channel “1.” If you rotate the **DIAL** knob to the location you just deleted, you will observe that it is now invisible.

Note: Once deleted, the channel data cannot be recovered.

HOME Channel Memory

A special one-touch “HOME” channel is available (one for each of the five operating bands), to allow quick recall of a favorite operating frequency on each band. HOME memory storage is simple to accomplish:

DEFAULT HOME CHANNELS

BAND	FREQUENCY	
	USA VERSION	EXP VERSION
144 MHz Ham Band	146.520 MHz	144.000 MHz
250 MHz Band	250.000 MHz	250.000 MHz
350 MHz Band	350.000 MHz	350.000 MHz
430 MHz Ham Band	446.000 MHz	430.000 MHz
850 MHz Band	850.000 MHz	850.000 MHz

1. Select the desired frequency, while operating in the VFO mode. Be sure to set up any desired CTCSS or DCS tones, as well as any desired repeater offset. The power level may also be set at this time, if you wish to store it.
2. Press and hold in the [V/M(MW)] key for one second. A memory number will appear (blinking) on the display.
3. While the memory channel number is blinking, just press the [TONE(HM/RV)] key. The frequency and other data (if any) will now be stored in the special HOME channel register.
4. You may repeat this process on the other operating bands.
5. To recall the HOME channel, just press the [V/M(MW)] key momentarily while operating in the MR mode. From the VFO mode, press the [V/M(MW)] key twice. While you are operating on the Home channel, an “H” icon will appear on the display.



You may also append to an Alpha-numeric “Tag” to a Home channel:

1. Recall the HOME channel which you wish to append a label.
2. Press and hold in the [BAND(SET)] key for 1/2 second to enter the Set mode.
3. Rotate the **DIAL** knob to select Menu #24 (NM WRT).
4. Press the [BAND(SET)] key twice, then rotate the **DIAL** knob to select the first character in the name you wish to

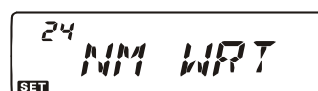

MEMORY OPERATION

REGULAR MEMORY CHANNEL OPERATION

store, the press the [BAND(SET)] key momentarily to move on to the next character. Letters, numbers, and symbols are available for storage.

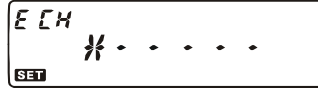

- Again rotate the **DIAL** knob to select the desired letter, number, or symbol, then press the [BAND(SET)] key momentarily to move on to the next character's slot. If you make a mistake, press the microphone's [DWN] button to move back to the previous character's slot, then re-select the correct letter, number, or symbol.

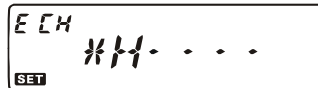



- Repeat the above step to program the remaining letters, numbers, or symbols of the desired label. A total of six characters may be used in the creation of a label.

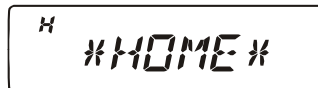

- When you have completed the creation of the label, press the [BAND(SET)] key momentarily to save the label, then press and hold in the [BAND(SET)] key momentarily for 1/2 second to normal operation.

- When recall the Home channel which is appended an alpha-numeric "Tag" (label), press the microphone's [B] key momentarily to switch the Home channel display between the "Frequency" format and "Alpha-numeric Tag" format.



 **Menu #16 (HM/REV) allows configuration of the way you can access the "HOME" channel. See page 70.**

Memory Bank Operation

Memory Bank Assignment



- Recall the memory channel to be assigned to a Memory Bank. Memory channels L1/U1 ~ L50/U50 (band/scanning limit memories) may not be assigned to a Memory Bank.

- Press and hold in the [SCAN(SEL)] key for 1/2 second, then rotate the **DIAL** knob to select the Memory Bank you want as the Memory Bank for this channel ("BANK1" ~ "BANK20").

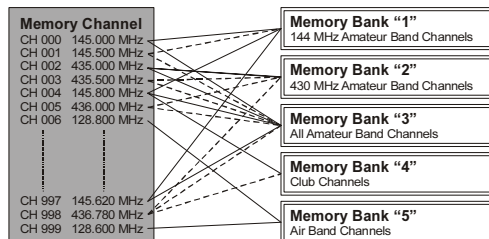

- Press and hold in the [V/M(MW)] key for 1/2 second to lock in the selected Memory Bank, then press the [V/M(MW)] key momentarily to copy the memory channel data into the Memory Bank.





-  **1) You may assign one memory channel into several Memory Banks.**
-  **2) The PMS memory channels (L1/U1 through L50/U50) may not be assigned to a Memory Bank.**

MEMORY OPERATION

REGULAR MEMORY CHANNEL OPERATION

Memory Bank Recall

1. Set the radio to the Memory mode by pressing the [V/M(MW)] key, if necessary.
2. Press and hold in the [SCAN(SEL)] key for 1/2 second, then rotate the **DIAL** knob to select the Memory Bank (“BANK 1” ~ “BANK20”).

3. Press the [BAND(SET)] key momentarily to lock in the selected Memory Bank.
4. In the Memory Bank mode of operation, you can only select memory channels within the current Memory Bank.
5. To change the Memory Bank to another Bank, press and hold in the [SCAN(SEL)] key for 1/2 second; now rotate the **DIAL** knob to select the new Memory Bank, then press the [BAND(SET)] key momentarily to lock in the new Memory Bank.
6. To exit from Memory Bank operation, press and hold in the [SCAN(SEL)] key for 1/2 second, then rotate the **DIAL** knob to select “NOBANK;” now press the [BAND(SET)] key momentarily.



Deleting a Memory Channel from a Memory Bank

1. In the Memory Bank mode, recall the memory channel to be deleted from the Memory Bank.
2. Press and hold in the [SCAN(SEL)] key for 1/2 second, then press and hold in the [V/M(MW)] key for 1/2 second. The channel will now be deleted from the Memory Bank, but the memory register itself will still be available in the non-Bank mode.

Memory Only Mode

Once memory channel programming has been completed, you may place the radio in a “Memory Only” mode, whereby VFO operation is impossible. This may be particularly useful during public-service events where a number of operators may be using the radio for first time, and ultimate simplicity of channel selection is desired.

To place the radio into the Memory Only mode:

1. Turn the radio off.
2. Press and hold in the [MHz(PRI)] key while turning the radio on.
3. Rotate the **DIAL** knob to select the (F-6 M-ONLY) option, then press and hold in the [BAND(SET)] key for 1/2 second.

To return to normal operation, repeat the above steps.

MEMORY OPERATION

HYPER MEMORY CHANNEL OPERATION

The **FT-7800R** usually stores, into memory, the operating frequency and some aspects of operating status (such as VFO scan, CTCSS/DCS data, repeater shift, power level etc.). However, the “Hyper Memory” Mode allows you to store the total current configuration of the radio into a special “Hyper” memory bank.

Hyper Memory Storage

1. Set up the transceiver according to the desired configuration.
2. Press and hold in, for two seconds, the Hyper Memory key ([1] through [5]), corresponding to the Hyper Memory channel into which you wish to store this configuration.

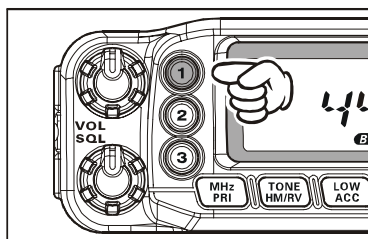

Hyper Memory Recall

Press the appropriate Hyper Memory key ([1] through [5]) to recall the desired Hyper Memory channel.

 ***On Hyper Memory Channels “2” through “5,” the current (original) configuration will be lost when you recall any other Hyper Memory Channel. To prevent this from happening, press and hold in the (current) Hyper Memory key to store the current configuration into that Hyper Memory Channel before recalling another Hyper Memory Channel, or set Menu #17 (HYPER) to enable the Automatic Writing feature for all Hyper Memories, including Hyper Memory “1.” See page 70 for details.***

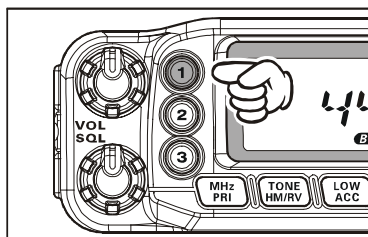

MEMORY OPERATION

WEATHER BROADCAST CHANNEL OPERATION

The VHF Weather Broadcast Station Memory Channel Bank has been pre-programmed at the factory, for quick selection of NOAA weather information stations.

1. Press and hold in the [**LOW(ACC)**] key for 1/2 second to recall the Weather Broadcast Station Memory Channel Bank.



2. Rotate the **DIAL** knob to select the desired Weather Broadcast channel.
3. If you wish to scan this bank to search for louder stations, just press the **PTT** switch. When the scanner pauses on a station, press the **PTT** key once to halt the scan, or press it twice to restart the scan.
4. To exit to normal operation, press and hold in the [**LOW(ACC)**] key for 1/2 second.

CH	FREQUENCY	CH	FREQUENCY
1	162.550 MHz	6	162.500 MHz
2	165.400 MHz	7	162.525 MHz
3	162.475 MHz	8	161.650 MHz
4	162.425 MHz	9	161.775 MHz
5	162.450 MHz	10	163.275 MHz

Severe Weather Alert

In the event of extreme weather disturbances, such as storms and hurricanes, the NOAA (National Oceanic and Atmospheric Administration) sends a weather alert accompanied by a 1050 Hz tone and subsequent weather report on one of the NOAA weather channels.

SCANNING

The **FT-7800R** allows you to scan just the memory channels, the entire operating band, or a portion of that band. It will halt on signals encountered, so you can talk to the station(s) on that frequency, if you like.

Scanning operation is basically the same in each of the above modes. Before you begin, take a moment to select the way in which you would like the scanner to resume scanning after it halts on a signal.

Setting the Scan-Resume Technique

Three options for the Scan-Resume mode are available:

BUSY: In this mode, the scanner will halt on a signal it encounters. Two seconds after the carrier has dropped because the other station(s) ceased transmission, the scanner will resume.

TIME: In this mode, the scanner will halt on a signal it encounters, and will hold there for five seconds. If you do not take action to disable the scanner within five seconds, the scanner will resume even if the stations are still active.

HOLD: In this mode, the scanner will halt on a signal it encounters. It will not restart automatically; rotate the **DIAL** knob to re-initiate scanning if you wish to resume.

To set the Scan-Resume mode:

1. Press and hold in the [**BAND(SET)**] key for 1/2 second to enter the Set mode.
2. Rotate the **DIAL** knob to select Menu #37 (SCAN).
3. Press the [**BAND(SET)**] key momentarily, then rotate the **DIAL** knob to select the desired scan-resume mode.
4. Press the [**BAND(SET)**] key momentarily to save the new setting, then press and hold in the [**BAND(SET)**] key for 1/2 second to exit to normal operation.



Note: The default condition for this Menu Item is "BUSY."

VFO SCANNING

This mode allows you to scan the entire current operating band.

1. Select the VFO mode by pressing the [V/M(MW)] key, if necessary.
2. Press and hold in the [SCAN(SEL)] key for 1/2 second, then rotate the **DIAL** knob to select the bandwidth for the VFO scanner. Available selections are ± 1 MHz, ± 2 MHz, ± 5 MHz, ALL, PMS-X, and BAND.





ALL: The scanner will sweep all frequencies between 108 - 520 MHz and 700 -999.990 MHz.

PMS-X: The scanner will sweep frequencies within the currently-selected PMS frequency pair (X is PMS memory channel number). See page 45 for details.

BAND: The scanner will sweep frequencies only on the current band.

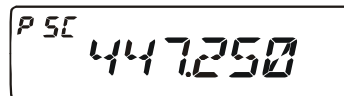
3. Press the [SCAN(SEL)] key momentarily to start scanning.
4. The “P-XX” indication will appear on the display if you engage PMS scanning, while the “P SC” indication will appear on the display when other scanning modes are engaged.
5. If and when the scanner encounters a signal strong enough to open the squelch, the scanner will halt temporarily; the decimal point of the frequency display will blink during this “Pause” condition.
6. The scanner will then resume according to the Scan-Resume mode selected in the previous section.
7. To cancel scanning, press the [SCAN(SEL)] key momentarily again (or press the microphone’s **PTT** key).



 **1) When you start scanning, the FT-7800R will be changing frequency in the upward direction. If you want to change direction of the scan while it is underway, rotate the DIAL knob one click in the opposite direction (in this case, one click counter-clockwise). You’ll see the scanner turn around and change frequency downward!**

2) Pressing and holding in the microphone’s [UP] or [DWN] key will cause the scanner to sweep frequencies only on the current band. If you would like the scanner not to be restricted to the current band, you may change Menu #46 (VFO.BND) to allow the scanner to hop to the low edge of the next-highest band when the VFO frequency reaches the high end of the current band (or vice-versa). See page 75 for details.

SCANNING

MEMORY SCANNING

Memory scanning is similarly easy to initiate:

1. Set the radio to the Memory mode by pressing the [V/M(MW)] key, if necessary.
2. Press the [SCAN(SEL)] key to initiate scanning.
3. As with VFO scanning, the scanner will halt on any signal encountered that is strong enough to open the squelch; it will then resume scanning according to the Scan-Resume mode set previously.
4. To cancel scanning, press the [SCAN(SEL)] key again (or press the microphone's PTT key).



You may initiate the memory channel scan by pressing and holding in the microphone's [UP] or [DWN] key.

How to Skip (Omit) a Channel During Memory Scan Operation

Some continuous-carrier stations like a Weather Broadcast station will seriously impede scanner operation if you are using the "Carrier Drop" Scan-Resume mode, as the incoming signal will not pause long enough for the transceiver to resume scanning. Such channels may be "Skipped" during scanning, if you like:

1. Set the radio to the Memory Mode by pressing the [V/M(MW)] key, if necessary.
2. Rotate the **DIAL** knob to select the Memory Channel to be skipped during scanning.
3. Press and hold in the [BAND(SET)] key for 1/2 second to enter the Set mode.
4. Rotate the **DIAL** knob to select Menu #40 (SKIP).
5. Press the [BAND(SET)] key momentarily, then rotate the **DIAL** knob to "SKIP." The current Memory Channel will now be ignored during scanning. The small "SKIP" icon will also appear when you recall the "Skipped" memory channel manually. The "ONLY" selection is used for "Preferential Memory Scan," described in the next column.
6. Press the [BAND(SET)] key momentarily to save the new setting, then press and hold in the [BAND(SET)] key for 1/2 second to exit to normal operation.
7. To re-institute a channel into the scanning loop, select "OFF" in step 5 above (the "Skipped" channel will still be accessible via manual channel selection methods using the **DIAL** knob in the MR mode, whether or not it is locked out of the scanning loop).



MEMORY SCANNING

Preferential Memory Scan

The **FT-7800R** also allows you to set up a “Preferential Scan List” of channels which you can “flag” within the memory system. These channels are designated by a “◀” icon when you have selected them, one by one, for the Preferential Scan List.



When you initiate memory scanning, beginning on a channel with the “◀” icon appended, only those channels bearing the “◀” icon will be scanned. If you initiate scanning on a channel which does not have the “◀” icon appended, you will scan all channels including those with the “◀” icon appended.

Here is the procedure for setting up and using the Preferential Scan List:

1. Press the [**V/M(MW)**] key momentarily to enter the Memory Recall mode, if you are not using memories already.
2. Rotate the **DIAL** knob to select the channel which you wish to add to the Preferential Scan List.
3. Press and hold in the [**BAND(SET)**] key for 1/2 second to enter the Set mode.
4. Rotate the **DIAL** knob to select Menu #40 (SKIP).
5. Press the [**BAND(SET)**] key momentarily, then rotate the **DIAL** knob to “ONLY.” The current channel is listed on the “Preferential Scan List.”
6. When you have made your selections, press the [**BAND(SET)**] key momentarily to save the new setting, then press and hold in the [**BAND(SET)**] key for 1/2 second to exit to normal operation.
7. To remove a channel from the Preferential Scan List, select “OFF” in step 5 above.



To initiate Preferential Memory Scan:

1. Press and hold in the [**BAND(SET)**] key for 1/2 second to enter the Set mode.
2. Rotate the **DIAL** knob to select Menu #38 (SCN MD).
3. Press the [**BAND(SET)**] key momentarily, then rotate the **DIAL** knob to “ONLY.”
4. Press the [**BAND(SET)**] key momentarily to save the new setting, then press and hold in the [**BAND(SET)**] key for 1/2 second to exit to normal operation.
5. Now, press the [**BAND(SET)**] key momentarily to initiate Preferential Memory Scanning. Only the channels which have the “◀” icon appended to the channel number will be scanned.
6. To cancel Preferential Memory Scanning, select “MEM” in step 3 above.





SCANNING

MEMORY SCANNING

Memory Bank Scan

When the Memory Bank feature is engaged, the scanner sweeps only memory channels in the current Memory Bank. However, if the Memory Bank Link Scan feature is enabled, you may sweep the memory channels in several Memory Banks which you have selected.

To enable the Memory Bank Link Scan feature:



1. Set the radio to the Memory mode by pressing the [V/M(MW)] key, if necessary.
2. Press and hold in the [SCAN(SEL)] key for 1/2 second, then rotate the **DIAL** knob to select the first Memory Bank (“BANK 1” ~ “BANK20”) you wish to sweep using Memory Bank Link Scan. The display shows 'SEL' in the top left corner and 'BANK 14' in the center.
3. Press the [SCAN(SEL)] key momentarily. The current Memory Bank will now be swept during Memory Bank Scan. A “decimal point” will be appended on the Memory Bank number indication. The display shows 'SEL' in the top left corner and 'BANK 14.' in the center.
4. Repeat steps 2 and 3 above, to append the “decimal point” to any other Memory Banks you wish to sweep.
5. Now, press and hold in the [SCAN(SEL)] key for 1/2 second to initiate scanning.
6. To remove a Memory Bank from the Memory Bank Link Scan, repeat step 2 and 3 above, to delete the “decimal point” from the Memory Bank number indication.

Weather Alert Scan

This feature allows you to check a Weather Broadcast Memory Channel while operating on a VFO scan or Memory channel scan.

When the Weather Alert Scan feature is engaged, the **FT-7800R** will check the Weather Broadcast Memory Channels for activity every five seconds while operating on a VFO scan or Memory channel scan.

To enable the Weather Alert Scan feature:

1. Press and hold in the [BAND(SET)] key for 1/2 second to enter the Set mode.
2. Rotate the **DIAL** knob to select Menu #48 (WX ALT).
3. Press the [BAND(SET)] key momentarily, then rotate the **DIAL** knob to “ALT.ON” (to enabling the Weather Alert Scan feature). The display shows '48' in the top left corner, 'WX ALT' in the center, and 'SET' in the bottom left corner.
4. Press the [BAND(SET)] key momentarily to save the new setting, then press and hold in the [BAND(SET)] key for 1/2 second to exit to normal operation. The display shows '48' in the top left corner, 'ALT. ON' in the center, and 'SET' in the bottom left corner.
5. To disable the Weather Alert Scan feature, select “ALT.OFF” in step 3 above.



When the Weather Alert Scan feature is engaged, the Scan-Resume mode is fixed to “TIME.”

SCANNING

PROGRAMMABLE (BAND LIMIT) MEMORY SCAN (PMS)

This feature allows you to set sub-band limits for either scanning or manual VFO operation. For example, you might wish to set up a limit (in North America) of 144.300 MHz to 148.000 MHz so as to prevent encroachment into the SSB/CW “Weak Signal” portion of the band below 144.300 MHz. Here’s how to do this:

1. Set the radio to the VFO mode by pressing the [V/M(MW)] key, if necessary.
2. Using the techniques learned earlier, store 144.300 MHz into Memory Channel “L1” (the “L” designates the Lower sub-band limit).
3. Likewise, store 148.000 MHz into Memory Channel “U1” (the “U” designates the Upper sub-band limit).
4. Switch to the Memory mode by pressing the [V/M(MW)] key once, then rotate the **DIAL** knob to select Memory Channel “L1.”
5. Press the [BAND(SEL)] key momentarily to start PMS operation; the “**MT**” label will appear on the display. Tuning and scanning (engaged by pressing the [SCAN(SEL)] key momentarily) will now be limited within the just-programmed range.
6. Fifty pairs of Band Limit memories, labeled L1/U1 through L50/U50, are available. You therefore can set upper and lower operation limits on a number of bands, if you like.

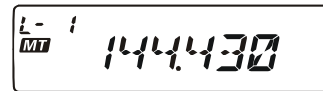
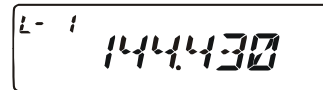

SCANNING

“PRIORITY CHANNEL” SCANNING (DUAL WATCH)

The **FT-7800R**'s scanning features include a two-channel scanning capability which allows you to operate on a VFO, Memory channel, Home channel, or Weather Broadcast Channel, while periodically checking a user-defined “Priority” Memory Channel for activity. If a station is received on the “Priority” Channel which is strong enough to open the Squelch, the scanner will pause on that station in accordance with the Scan-Resume mode set via Menu #37 (SCAN). See page 73.

Here is the procedure for activating Priority Channel Dual Watch operation:

VFO Priority

1. Recall the memory channel you wish to use as the “Priority” frequency.
2. Now set the **FT-7800R** for operation on a VFO frequency.
3. Press and hold in the **[MHz(PRI)]** key for 1/2 second to activate the VFO Priority mode. The display will remain on the VFO frequency, but every five seconds the **FT-7800R** will check the Priority Channel (memory channel) for activity. 
4. Press and hold in the **[MHz(PRI)]** key for 1/2 second to disable the VFO Priority mode and exit to regular VFO operation.

Memory Priority

1. Store the frequency you wish to be the “Priority” Channel into memory channel “1.”
2. Now set the **FT-7800R** for operation on another memory channel.
3. Press and hold in the **[MHz(PRI)]** key for 1/2 second to activate the Memory Priority mode. The display will remain on the current memory channel frequency, but every five seconds the **FT-7800R** will check the Priority Channel (memory channel “1” for activity. 
4. Press and hold in the **[MHz(PRI)]** key for one second to disable the Memory Priority mode and exit to regular memory operation.



When the Memory Bank feature is activated, the FT-7800R will check the lowest memory channel in the Memory Bank as the priority channel.

HOME Priority

1. Recall the memory channel you wish to use as the “Priority” frequency.
2. Now set the **FT-7800R** for operation on a HOME channel.
3. Press and hold in the **[MHz(PRI)]** key for 1/2 second to activate the HOME Priority mode. The display will remain on the HOME channel frequency, but every five seconds the **FT-7800R** will check the Priority Channel (memory channel) for activity. 
4. Press and hold in the **[MHz(PRI)]** key for 1/2 second to disable the HOME Priority mode and exit to regular Home channel operation.

SCANNING

“PRIORITY CHANNEL” SCANNING (DUAL WATCH)

WX Priority

1. Recall the memory channel you wish to use as the “Priority” frequency.
2. Now set the **FT-7800R** for operation on a WX channel by pressing and holding in the [**LOW(ACC)**] key for 1/2 second.
3. Press and hold in the [**MHz(PRI)**] key for 1/2 second to activate the WX Priority mode. The display will remain on the WX channel frequency, but every five seconds the **FT-7800R** will check the Priority Channel (memory channel) for activity.
4. Press and hold in the [**MHz(PRI)**] key for 1/2 second to disable the WX Priority mode and exit to regular WX channel operation.



Priority Revert Mode

During Priority channel operation (Dual Watch), a special feature is available which will allow you to move to the Priority channel instantly, without waiting for activity to appear on the Priority channel.

When this feature is enabled, and Priority monitoring is engaged, just press the microphone’s **PTT** switch; operation will instantly revert to the Priority channel.

To enable the Priority Revert operation:

1. Press and hold in the [**BAND(SET)**] key for 1/2 second to enter the Set mode.
2. Rotate the **DIAL** knob to select Menu #34 (PRI.RVT).
3. Press the [**BAND(SET)**] key momentarily, then rotate the **DIAL** knob to change the setting to “RVT.ON.”
4. Press the [**BAND(SET)**] key momentarily to save the new setting, then press and hold in the [**BAND(SET)**] key for 1/2 second to exit to normal operation.
5. To disable Priority Revert operation, select “RVT.OFF” in step 3 above.



SMART SEARCH

The Smart Search feature allows you to load frequencies automatically according to where activity is encountered by your radio. When Smart Search is engaged, the transceiver will search above and below your current frequency, storing active frequencies as it goes (without stopping on them even momentarily); these frequencies are stored into a special Smart Search memory band, consisting of 31 memories (15 above the current frequency, 15 below the current frequency, plus the current frequency itself).

The Smart Search feature is especially useful when visiting a city for the first time, where you may be unfamiliar with the repeater frequencies; Smart Search discovers where the local activity is to be found, and automatically loads those frequencies for you.

Two basic operating modes for Smart Search are available:

SINGLE: In this mode, the transceiver will sweep the current band once in each direction starting on the current frequency. All channels where activity is present will be loaded into the Smart Search memories; whether or not all 31 memories are filled, the search will stop after one sweep in each direction.

CONT: In this mode, the transceiver will make one pass in each direction as with One-Shot searching; if all 31 channels are not filled after the first sweep, however, the radio will continue sweeping until they are all filled.

Setting the Smart Search Mode

1. Press and hold in the [**BAND(SET)**] key for 1/2 second to enter the Set mode.
2. Rotate the **DIAL** knob to select Menu #36 (S SRCH).
3. Press the [**BAND(SET)**] key momentarily, then rotate the **DIAL** knob to select the desired Smart Search mode (see above).
4. Press the [**BAND(SET)**] key momentarily to save the new setting, then press and hold in the [**BAND(SET)**] key for 1/2 second to exit to normal operation.

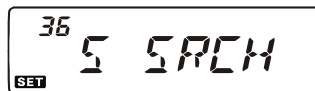

SMART SEARCH

Activating the Smart Search

1. Set the radio to the VFO mode by pressing the [V/M(MW)] key, if necessary.
2. Press the [S.SCH(ARTS)] key momentarily to begin the Smart Search scanning.
3. As active channels are detected, you will observe the number of “loaded” channels increasing in the regular memory channel window.
4. Depending on the mode you set for Smart Search operation (“SINGLE” or “CONT”), the Smart Search scan will eventually terminate, and the LCD will revert to Smart Search Memory Channel “C.”
5. To recall the Smart Search memories just stored, rotate the DIAL knob or press the microphone’s [UP]/[DWN] keys.
6. If you find particular channels which you wish to store into “regular” memory channels, follow the memory storage procedures described on page 32.
7. To return to normal operation, just press the [V/M(MW)] key.



The Smart Search memories are so-called “soft” memories; they will be lost if you exit the Smart Search mode or initiate a new Smart Search sweep.

ARTS™ : AUTO RANGE TRANSPONDER SYSTEM

The ARTS feature uses DCS signaling to inform both parties when you and another ARTS-equipped station are within communications range. This may be particularly useful during Search-and Rescue situations, where it is important to stay in contact with other members of your group.

Both stations must set up their DCS codes to the same code number, then activate their ARTS feature using the command appropriate for their radio. Alert ringers may be activated, if desired.

Whenever you push the **PTT** switch, or every 25 seconds after ARTS is activated, your radio will transmit a signal which includes a (subaudible) DCS signal for about one second. If the other radio is in range, the beeper will sound (if enabled) and the display will show “IN.RNG” as opposed to the out of range display “OUT.RNG” in which ARTS operation begins.



Whether you talk or not, the polling every 25 seconds will continue until you de-activate ARTS. Every 10 minutes, moreover, you can have your radio transmit your callsign via CW, so as to comply with identification requirements. When ARTS is de-activated, DCS will also be deactivated (if you were not using it previously in non-ARTS operation).

If you move out of range for more than one minute (two pollings), your radio will sense that no signal has been received, three beeps will sound, and the display will revert to “OUT.RNG.” If you move back into range, your radio will again beep, and the display will change back to the “IN.RNG” indication.

During ARTS operation, it is not possible to change the operating frequency or other settings; you must terminate ARTS in order to resume normal operation. This is a safety feature designed to prevent accidental loss of contact due to channel change, etc. Here is how to activate ARTS:

Basic ARTS Setup and Operation

1. Set your radio and the other radio(s) to the same DCS code number, per the discussion on page 29.
2. Press and hold in the [**S.SCH(ARTS)**] key for 1/2 second. You will observe the “OUT. RNG” display on the LCD. ARTS operation has now commenced.
3. Every 25 seconds, your radio will transmit a “polling” call to the other station. When that station responds with its own ARTS polling signal, the display will change to “IN.RNG” to confirm that the other station’s polling code was received in response to yours.
4. Press and hold in the [**S.SCH(ARTS)**] key for 1/2 second to exit ARTS operation and resume normal operation of the transceiver.

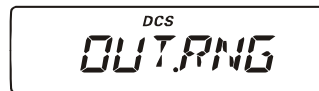

ARTS™ : AUTO RANGE TRANSPONDER SYSTEM

ARTS Polling Time Options

The ARTS feature may be programmed to poll every 25 seconds (default value) or 15 seconds. The default value provides maximum battery conservation, because the polling signal is sent out less frequently. To change the polling interval:

1. Press and hold in the [**BAND(SET)**] key for 1/2 second to enter the Set mode.
2. Rotate the **DIAL** knob to select Menu #3 (AR INT).
3. Press the [**BAND(SET)**] key momentarily, then rotate the **DIAL** knob to select the desired polling interval (15 or 25 seconds).
4. Press the [**BAND(SET)**] key momentarily to save the new setting, then press and hold in the [**BAND(SET)**] key for 1/2 second to exit to normal operation.



The display shows the number '3' in the top left corner, followed by 'AR INT' in the center. A small 'SET' indicator is visible in the bottom left corner of the display area.

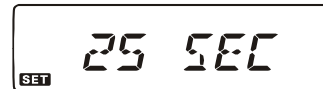

The display shows '25 SEC' in the center. A small 'SET' indicator is visible in the bottom left corner of the display area.

ARTS Alert Beep Option

The ARTS feature allows two kinds of alert beeps (with the additional option of turning them off), so as to alert you to the current status of ARTS operation. Depending on your location and the potential annoyance associated with frequent beeps, you may choose the Beep mode which best suits your needs. The choices are:

- INRANG:** The beeps are issued only when the radio first confirms that you are within range, but does not re-confirm with beeps thereafter.
- ALWAYS:** Every time a polling transmission is received from the other station, the alert beeps will be heard.
- OFF:** No alert beeps will be heard; you must look at the display to confirm current ARTS status.

To set the ARTS Beep mode, use the following procedure:

1. Press and hold in the [**BAND(SET)**] key for one second to enter the Set mode.
2. Rotate the **DIAL** knob to select Menu #2 (AR BEP).
3. Press the [**BAND(SET)**] key momentarily, then rotate the **DIAL** knob to select the desired ARTS Beep mode (see above).
4. Press the [**BAND(SET)**] key momentarily to save the new setting, then press and hold in the [**BAND(SET)**] key for 1/2 second to exit to normal operation.

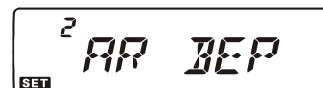

The display shows the number '2' in the top left corner, followed by 'AR BEP' in the center. A small 'SET' indicator is visible in the bottom left corner of the display area.



The display shows 'INRANG' in the center. A small 'SET' indicator is visible in the bottom left corner of the display area.

ARTS™ : AUTO RANGE TRANSPONDER SYSTEM

CW Identifier Setup

The ARTS feature includes a CW identifier, as discussed previously. Every ten minutes during ARTS operation, the radio can be instructed to send “DE (your callsign) K” if this feature is enabled. The callsign field may contain up to 6 characters.

Here’s how to program the CW Identifier:

1. Press and hold in the [**BAND(SET)**] key for 1/2 second to enter the Set mode.
2. Rotate the **DIAL** knob to select Menu #8 (CW WRT).
3. Press the [**BAND(SET)**] key momentarily.
4. Press the [**BAND(SET)**] key momentarily again to enable entry of your callsign.
5. Rotate the **DIAL** knob one click clockwise to begin entry of the letters and numbers in your callsign.
6. Press the [**BAND(SET)**] key momentarily to set the first letter or number in your callsign.
7. When the correct character has been selected, press the [**BAND(SET)**] key momentarily to move on to the next character.
8. Repeat steps 6 and 7 as many times as necessary to complete your callsign.
9. Press the [**SCAN(SEL)**] key to delete all data after the cursor that may have been previously stored (erroneously).
10. When you have entered your entire callsign, press and hold in the [**BAND(SET)**] key for 1/2 second to confirm the callsign, then press and hold in the [**BAND(SET)**] key for 1/2 second to exit to normal operation.
11. Press and hold in the [**BAND(SET)**] key for 1/2 second to enter the Set mode again, then rotate the **DIAL** knob to select Menu #7 (CWID).
12. Press the [**BAND(SET)**] key momentarily, then rotate the **DIAL** knob to select “TX ON” (to enable the CW identifier).
13. Press the [**BAND(SET)**] key momentarily to save the new setting, then press and hold in the [**BAND(SET)**] key for 1/2 second to exit to normal operation.

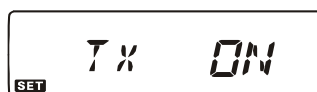
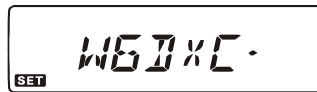
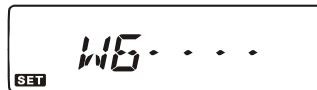
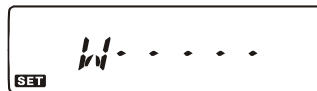
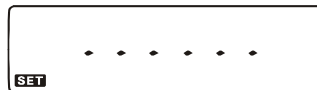

NOTE

DTMF AUTODIALER OPERATION

Sixteen DTMF Autodialer memories are available on the **FT-7800R**. These DTMF Autodialer memories can store up to 16 digits of a telephone number for repeater autopatch or other uses.

To load DTMF Autodialer memories, use following procedure:

1. Press and hold in the [**BAND(SET)**] key for 1/2 second to enter the Set mode.
2. Rotate the **DIAL** knob to select Menu #14 (DT WRT).
3. Press the [**BAND(SET)**] key momentarily, then rotate the **DIAL** knob to select the DTMF Autodialer memory channel number (“d-1” through “d-16”) into which you wish store a telephone number.
4. Press the [**BAND(SET)**] key momentarily, then rotate the **DIAL** knob to select the first digit of the telephone number you wish to store.
5. When you have selected the correct digit, press the [**BAND(SET)**] key momentarily. Now, rotate the **DIAL** knob to select the second of the 16 available numbers in this current DTMF Audodialer memory register.
6. Repeat this procedure for each digit in the telephone number. Press the [**SCAN(SEL)**] key momentarily to delete any previously-stored data after the cursor. If you make a mistake, press the microphone’s [**DWN**] key to move back to the first digit, then re-enter the correct number.
7. When entry of all digits is complete, press and hold in the [**BAND(SET)**] key for 1/2 second to save the new setting.
8. If you wish to store another DTMF string, rotate the **DIAL** knob to select another DTMF memory register, then repeat steps 4 through 7 above.
9. When all required DTMF memories are filled to your satisfaction, press and hold in the [**BAND(SET)**] key for 1/2 second to exit to normal operation.

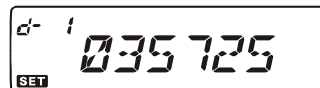
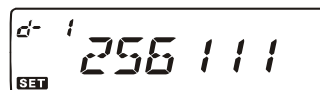
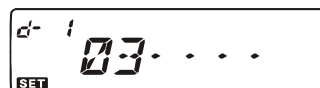
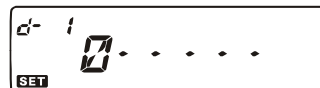
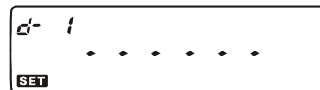
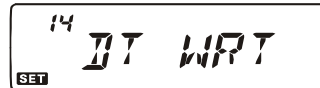

DTMF AUTODIALER OPERATION

To transmit the memorized telephone number, use the following procedure:

1. Press the **PTT** switch.
2. While still holding the **PTT** switch in, press the microphone's [**UP**]/[**DWN**] key to select the DTMF Autodialer memory channel to be transmitted then press the [**BAND(SET)**] key momentarily to transmit the tone string.

Once you have pressed the [**BAND(SET)**] key in the above step, you can release the PTT switch, as the Autodialer will transmit the whole DTMF string automatically.

To speed at which the DTMF digits are sent can be changed. Three speed levels are available: 50 ms (High: 10 digits per second), 75 ms (Mid: 7 digits per second), and 100 ms (Low: 5 digits per second).

To select the speed, use the following procedure:

1. Press and hold in the [**BAND(SET)**] key for 1/2 second to enter the Set mode.
2. Rotate the **DIAL** knob to select Menu #13 (DT SPD).
3. Press the [**BAND(SET)**] key momentarily, then rotate the **DIAL** knob to select the desired speed (50/75/100 ms).
4. Press the [**BAND(SET)**] key momentarily to save the new setting, then press and hold in the [**BAND(SET)**] key for 1/2 second to exit to normal operation.

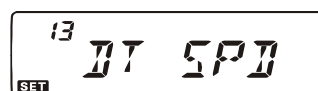

You can also set a longer delay between the time you press the [**BAND(SET)**] key (with **PTT** switch pressed) and the first DTMF digit is sent.





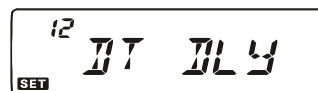

To set a delay time, use the following procedure:

1. Press and hold in the [**BAND(SET)**] key for 1/2 second to enter the Set mode.
2. Rotate the **DIAL** knob to select Menu #12 (DT DLY).
3. Press the [**BAND(SET)**] key momentarily, then rotate the **DIAL** knob to select the desired time (50/100/250/450/750/1000 ms).
4. Press the [**BAND(SET)**] key momentarily to save the new setting, then press and hold in the [**BAND(SET)**] key for 1/2 second to exit to normal operation.









INTERNET CONNECTION FEATURE







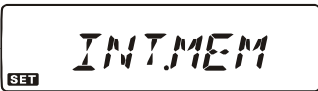

The **FT-7800R** can be used to access a repeater or base station which is configured to provide access to the Vertex Standard WIRESTM (Wide-Coverage Internet Repeater Enhancement System) operating in the "SRG" ("Sister Radio Group") mode.

1. Press the [] key momentarily to activate the WIRESTM access capability. The "" icon will appear on the display. 
2. Press and hold in the [] key for 1/2 second, rotate the **DIAL** knob to select the access number (ICOD "0" ~ "9," "A," "B," "C," "D," "E (*)," or "F (#)") corresponding to the WIRESTM repeater to which you wish to establish an Internet link (ask your repeater owner/operator if you don't know the access numbers in the network), then press the [] key momentarily to lock in the selected access number. 
3. With the WIRESTM capability activated (as in step 1 above), the **FT-7800R** will generate a brief (0.1 second) DTMF tone according to your selection in step 2. This DTMF tone is sent at the beginning of every transmission to establish or maintain the link to the remote WIRESTM repeater.
4. To disable the WIRESTM access capability, press the [] key again.

You may access other Internet Linking Systems (including WIRESTM in the "FRG" mode) that use a DTMF string for access.

1. Press and hold in the [**BAND(SET)**] key for 1/2 second to enter the Set mode.
2. Rotate the **DIAL** knob to select Menu #14 (DT WRT). 
3. Press the [**BAND(SET)**] key momentarily, then load the DTMF tones which you wish to use to establish an Internet link (ask your repeater owner/operator if you don't know the access numbers in the network) into the desired DTMF Memory channel.
 - 1) Rotate the **DIAL** knob to select the DTMF Autodialer memory channel number ("d-1" through "d-16"). 
 - 2) Press the [**BAND(SET)**] key momentarily.
 - 3) Rotate the **DIAL** knob to select the DTMF code, then press the [**BAND(SET)**] key momentarily to move the digit. 
 - 4) Repeat step (3) above to complete the DTMF string. 
 - 5) Press and hold the [**BAND(SET)**] key for 1/2 second to save the new setting, then press and hold the [**BAND(SET)**] key for 1/2 second to exit to normal operation. 
4. Press and hold in the [**BAND(SET)**] key for 1/2 second to enter the Set mode again, then rotate the **DIAL** knob to select Menu #18 (I NET). 

INTERNET CONNECTION FEATURE

5. Press the [**BAND(SET)**] key momentarily, then rotate the **DIAL** knob to set this Item to “INT.MEM” (to enable the alternative Internet Link, and disable the WIRES™ SRG access option).
A rectangular display box with a small 'SET' icon on the left and the text 'INT.MEM' in the center.
6. Press the [**BAND(SET)**] key momentarily to save the new setting, then press and hold in the [**BAND(SET)**] key for 1/2 second to exit to normal operation.
7. Press the [] key momentarily to activate the Internet Link System. The “” icon will then appear on the display.
A rectangular display box with a small Internet icon on the left and the number '438.225' in the center.
8. Press and hold in the [] key for 1/2 second, rotate the **DIAL** knob to select the DTMF access number (“IMEM 1” ~ “IMEM16”) corresponding to the Internet link repeater to which you wish to establish an Internet link, then press the [] key momentarily to lock in the selected access number.
A rectangular display box with a small Internet icon on the left and the text 'IMEM 1' in the center.
9. With the Internet link feature activated (as in step 7 above), press the [] key while you are transmitting, to send out the DTMF tones according to your selection in step 8 (to establish the link to the Internet link repeater).
10. To disable the Internet link feature, press the [] key again.



To return to WIRES™, recall Menu #18 (I NET) then set it to “INT.COD.”

MISCELLANEOUS SETTINGS

TIME-OUT TIMER

The “Time-Out Timer” (TOT) feature is designed to force the transceiver into the “receive” mode after a preset time period of continuous transmission (the default is 6 minutes). This feature prevents your transceiver from transmitting a “dead carrier” for a long period of time in the event that the microphone **PTT** switch is accidentally locked in the “TX” condition.

The Time-Out Timer’s “switch-to-receive” time may be adjusted, in one minute increments, for any period between 1 and 30 minutes.

To change the default (6 minute) time setting, use the following procedure:

1. Press and hold in the [**BAND(SET)**] key for 1/2 second to enter the Set mode.
2. Rotate the **DIAL** knob to select Menu #45 (TOT).
3. Press the [**BAND(SET)**] key momentarily, then rotate the **DIAL** knob to select the desired interval (between 1 and 30 minutes), or OFF. You will hear a beep, while rotating the **DIAL** knob, as you pass the default six-minute selection.
4. Press the [**BAND(SET)**] key momentarily to save the new setting, then press and hold in the [**BAND(SET)**] key for 1/2 second to exit to normal operation.

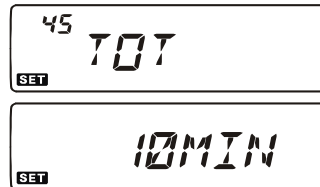

When the TOT Timer reaches 10 seconds before the TOT shut-down time, a ringer sounds to alert you to the impending shut-down.

AUTOMATIC POWER-OFF

The “Automatic Power-Off” (APO) feature will turn the radio completely off after a user-defined period of **PTT** switch or key/button inactivity. If you do not press any front panel keys or buttons, rotate the **DIAL** knobs or use the microphone’s keys and buttons, or transmit, and so long as the transceiver is not scanning or engaged in priority monitoring, the radio will shut itself off after the specified time period. This feature is useful in minimizing battery drain in a mobile installation if you forget to turn the transceiver off when you leave your vehicle.

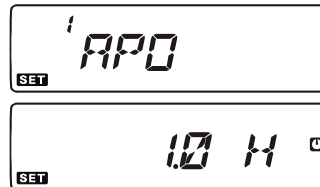

To activate the APO feature, use the following procedure:

1. Press and hold in the [**BAND(SET)**] key for 1/2 second to enter the Set mode.
2. Rotate the **DIAL** knob to select Menu #1 (APO).
3. Press the [**BAND(SET)**] key momentarily, then rotate the **DIAL** knob to set the desired “switch-off” time (between 0.5 and 12 hours in 0.5 hours increments), or OFF (the default selection).
4. Press the [**BAND(SET)**] key momentarily to save the new setting, then press and hold in the [**BAND(SET)**] key for 1/2 second to exit to normal operation.



MISCELLANEOUS SETTINGS

AUTOMATIC POWER-OFF

When APO is activated, the “” icon will appear on the LCD. If there is no action by you within the time interval programmed, the “” icon blinks and a ringer sounds 3 minutes before the APO shut-down time; three minutes thereafter, the microprocessor will shut down the radio automatically.



Just press and hold in the **PWR** () switch for 1/2 second to turn the transceiver back on after an APO shutdown, as usual.

MIC GAIN CONTROL

You can reduce the microphone input level when operating on tightly-clustered frequencies (channel spacing of 12.5 or 15 kHz). This will reduce the transmitter deviation, thus minimizing interference to other users.

To configure for the narrower bandwidth, use the following procedure:

1. Press and hold in the [**BAND(SET)**] key for 1/2 second to enter the Set mode.
2. Rotate the **DIAL** knob to select Menu #47 (WID.NAR).
3. Press the [**BAND(SET)**] key momentarily, then rotate the **DIAL** knob to change the display to “NARROW.”
4. Press the [**BAND(SET)**] key momentarily to save the new setting, then press and hold in the [**BAND(SET)**] key for 1/2 second to exit to normal operation.





To restore the normal (higher) microphone input level, select “WIDE” in step 3 above.

MISCELLANEOUS SETTINGS

PROGRAMMING THE KEY ASSIGNMENTS

Default **FT-7800R** functions have been assigned to “alternate” (press and hold in) function of the front panel’s **[LOW(ACC)]** key, as well as the Microphone’s **[P1]/[P2]/[P3]/[P4]** buttons’ functions (for the **MH-48A6J**; **[ACC]/[P]/[P1]/[P2]** buttons for **MH-42B6JS**) at the factory. These may be changed by the user, if you wish to utilize another function on one of these keys.

To program the function assigned to a key:

1. Press and hold in the **[BAND(SET)]** key for 1/2 second to enter the Set mode.
2. Rotate the **DIAL** knob to select the Menu Item to be configured (“#27 PRG PNL,” “#28 PRG P1 (PRG ACC),” “#29 PRG P2 (PRG P),” “#30 PRG P3 (PRG P1),” or “#31 PRG P4 (PRG P2)”).

3. Press the **[BAND(SET)]** key momentarily, then rotate the **DIAL** knob to select the function you wish to assign to the button you selected in the previous step.

4. Press the **[BAND(SET)]** key to save the new setting, then rotate the **DIAL** knob to select another programmable button to modify, if desired, and repeat the above steps.
5. Press the **[BAND(SET)]** key momentarily to save the new setting, then press and hold in the **[BAND(SET)]** key for 1/2 second to exit to normal operation.

MISCELLANEOUS SETTINGS

PROGRAMMING THE KEY ASSIGNMENTS

For Menu #27 PRG PNL

Function	Press and hold the [LOW(ACC)] key
< WX >	Recall the Weather Broadcast Channels.
< REV >	Reverses the transmit and receive frequencies during split-frequency operation.
< RPTR >	Selects Repeater Shift direction.
< SQ.OF >	Disable the noise squelch action, allowing you to hear very weak signals near the background noise level.
< LOCK >	Selects the Key locking schemes. (Short-cut to Menu #21: LOCK)
< DIM >	Sets the display Brightness.

For Menu #28 PRG P1 (PRG ACC), #29 PRG P2 (PRG P), #30 PRG P3 (PRG P1), #31 PRG P4 (PRG P2)

Function	Press the button	Press and hold the button
< SQ.OF >	Disable the noise squelch action, allowing you to hear very weak signals near the background noise level.	Disable the noise squelch action, allowing you to hear very weak signals near the background noise level.
< TCAL >	Activates 1750 Hz Tone Burst.	Activates 1750 Hz Tone Burst.
< SSCH >	Activate the Smart Search operation.	Activate the ARTS™ operation.
< ARTS >	Activate the ARTS™ operation.	–
< TN.FQ >	Select the CTCSS Tone Frequency. (Short-cut to Menu #44: TN FRQ)	–
< DCSC >	Select the DCS code. (Short-cut to Menu #9: DCS.COD)	–
< WX >	Recall the Weather Broadcast Channels.	–
< RPTR >	Selects Repeater Shift direction.	Selects Repeater Shift direction.
< PRI >	Activates the Priority Channel Scanning (Dual Watch).	–
< LOW >	Selects the transmit power output level.	Recall the Weather Broadcast Channels.
< TONE >	Activates the CTCSS or DCS operation.	Reverses the transmit and receive frequencies during split-frequency (repeater) operation.
< MHz >	Allows tuning in 1-MHz step on the VFO frequency.	Activates the Priority Channel Scanning (Dual Watch).
< REV >	Reverses the transmit and receive frequencies during split-frequency operation.	Selects Repeater Shift direction.
< HOME >	Recall the Home Channel.	Switch the Memory Channel display between the “Frequency” format and “Alpha-numeric Tag” format.
< BAND >	Switches operating band.	Enter the Set (“Menu”) mode.
< V/M >	Switches frequency control among the VFO, Memory System, and Home channel.	Transfer the VFO contents into a Memory register.
< SCAN >	Activate the Scanner.	Select the scan mode.

MISCELLANEOUS SETTINGS

DCS CODE INVERSION

The DCS system was first introduced in the commercial LMR (Land Mobile Radio) service, where it is now in widespread use. DCS is sometime referred to by its different proprietary names, such as DPL® (Digital Private Line®, a registered trademark of Motorola, Inc.).

DCS uses a codeword consisting of a 23-bit frame, transmitted (subaudible) at a data rate of 134.4 bps (bit/sec). Occasionally, signal inversion can result in the complement of a code to be sent or received. This prevents the receiver's squelch from opening with DCS enabled, as the decoded bit sequence would not match that selected for operation.

Typical situations that might cause inversion to occur are:

- Connection of an external receiver preamplifier.
- Operating through a repeater.
- Connection of an external linear amplifier.

Note that code inversion does not mean that any of the above listed equipment is defective!

In certain amplifier configurations, the output signal (phase) is inverted from the input. Small signal or power amplifiers having an odd number (1, 3, 5, etc.) of amplification stages may result in inversion of a transmitted or received DCS code.

While under most circumstances this should not occur (amplifier designs and industry standards take this into account), if you find that your receiver squelch does not open when both you and the other station are using a common DCS code, you or the other station (**but not both**) can try the following:

1. Press and hold in the [BAND(SET)] key for 1/2 second to enter the Set mode.

2. Rotate the **DIAL** knob to select Menu #10 (DCS.N/R).

3. Press the [BAND(SET)] key momentarily, then rotate the **DIAL** knob to select the following mode.

T/RX N: Encoder; Normal, Decoder; Normal

RX R: Encoder; Normal, Decoder; Reverse (Inverted)

TX R: Encoder; Reverse (Inverted), Decoder; Normal

T/RX R: Encoder; Reverse (Inverted), Decoder; Reverse (Inverted)

4. Press the [BAND(SET)] key momentarily to save the new setting, then press and hold in the [BAND(SET)] key for 1/2 second to exit to normal operation.

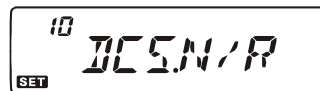

Remember to restore the default setting to "T/RX N" (Encoder; Normal, Decoder; Normal) when done.

RESET PROCEDURE

In the event of erratic operation of the transceiver, it is possible that data on the microprocessor may have become corrupted. While this is a highly unusual situation, the only path to recovery may involve resetting of the microprocessor. Here's how to do this:

1. Turn the radio off.
2. Press and hold in the [**MHz(PRI)**] key while turning the radio on.
3. Rotate the **DIAL** knob to select the resetting menu:
 - F-1 SETRST: Resets the Set (Menu) mode settings to their factory defaults.
 - F-2 HYPRST: Clears the Hyper Memory settings to factory defaults.
 - F-3 MEMRST: Clears the Regular Memory settings to factory defaults.
 - F-4 MB RST: Clears the Memory Bank Assignment.
 - F-5 ALLRST: Clears all memories and other settings to factory defaults.
4. Press and hold in the [**BAND(SET)**] key for 1/2 second to complete the reset procedure, once you have made your selection in step 3.

CLONING

You can transfer all data stored in one **FT-7800R** to another **FT-7800R** by utilizing the handy “Cloning” feature. This requires a user-constructed Cloning cable which connects the **DATA** jacks on the two transceivers, as shown below.

To clone from one transceiver to another, use the following procedure:

1. Insert the Cloning Cable into the **DATA** jack of each transceiver.
2. Turn both transceivers off, then press and hold in the [**MHz(PRI)**] key on each radio while turning the power on again.
3. Rotate the **DIAL** knob on each radio to select (F-7 CLONE), then press and hold in the [**BAND(SET)**] key. The display will disappear for a moment, then the “CLONE” notation will appear on the display.
4. On the “destination” radio, press the [**LOW(ACC)**] key. The “--RX--” indicator will appear on the display.
5. Now, on the “Source” radio, press the [**V/M(MW)**] key. The “--TX--” indicator will appear on the display, and the cloning data transfer will immediately begin.
6. If there is a problem during the cloning process, “ERROR” will be displayed. Check your cable connections, and try again.
7. If cloning was successful, “CLONE” will reappear on both displays.
8. Turn both transceivers off, then remove the Cloning Cable. Channel and operating data for both radios are now identical. They both may be turned on now for normal operation.

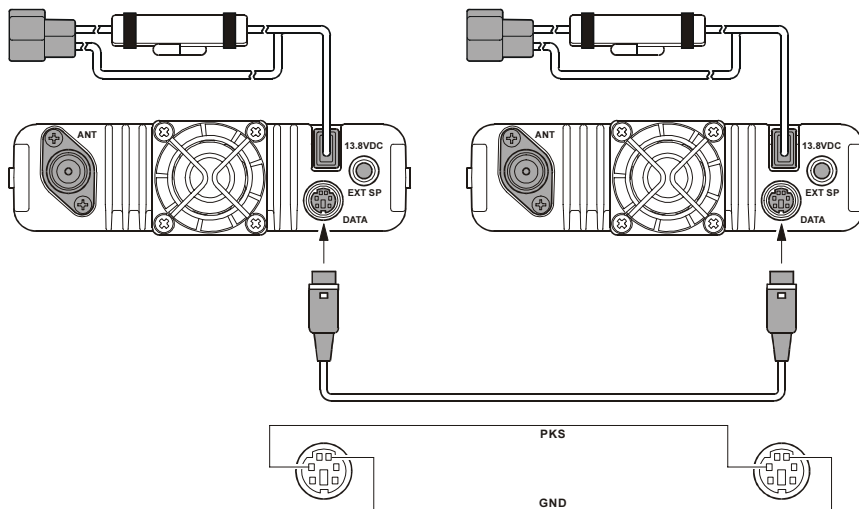
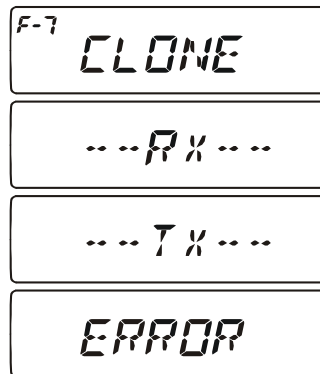

MENU (“SET”) MODE

The **FT-7800R** Set (Menu) mode, already described in parts of many previous chapters, is easy to activate and set. It may be used for configuration of a wide variety of transceiver parameters, some of which have not been detailed previously. Use the following procedure to activate the Set (Menu) mode:

1. Press and hold in the **[BAND(SET)]** key for 1/2 second to enter the Set mode.
2. Rotate the **DIAL** knob to select the Menu Item to be adjusted.
3. Press the **[BAND(SET)]** key momentarily to enable adjustment of the selected Menu item, then rotate the **DIAL** knob to perform the actual adjustment.
4. After completing your selection and adjustment, press the **[BAND(SET)]** key momentarily to save the new setting, then press and hold in the **[BAND(SET)]** key for 1/2 second to exit to normal operation.

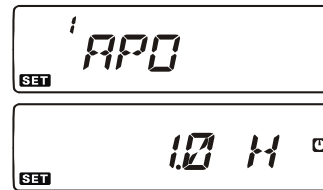

You may see the small letters “HYP” or “E CH” at the upper left-hand corner in the display while adjusting certain Menu items. These denote special characteristics of these particular Menu items:

- 1) The “HYP” character indicates that each Hyper Memory may have distinct parameters assigned to it pertaining to this Menu item;
- 2) The “E CH” character indicates that each Operating Mode (VFO, Memory Channel, or Home Channel) may have distinct parameters assigned to it pertaining to this Menu item.

MENU (“SET”) MODE

Item #	Menu Item	Function	Available Values (Default: <i>Bold Italic</i>)
1	APO	Selects the Automatic Power Off time (time before power goes off).	<i>OFF</i> /0.5 H ~ 12.0 H
2	AR BEP	Selects the ARTS beep mode.	<i>INRANG</i> /ALWAYS/OFF
3	AR INT	Selects the Polling Interval during ARTS operation.	<i>25sec</i> /15sec
4	ARS	Activates/deactivates the Automatic Repeater Shift feature.	ARS.ON/ARS.OFF (×)
5	BEEP	Enables/disables the beeper.	KEY/ <i>KEY+SC</i> /OFF
6	CLK.SFT	Shifting of CPU clock frequency.	SFT.ON/ <i>SFT.OFF</i>
7	CWID	Enables/disables the CW identifier during ARTS operation.	TX ON/ <i>TX OFF</i>
8	CW WRT	Stores your callsign into the CW identifier.	—
9	DCS.COD	Setting the DCS code.	104 DCS codes (<i>023</i>)
10	DCS.N/R	Selects “Normal” or “Inverted” DCS coding.	<i>TRX</i> N/RX R/TX R/TRX R
11	DIMMER	Setting of the Display brightness level.	<i>DIM 1</i> /DIM 2/DIM 3/DIM.OFF
12	DT DLY	Setting of the DTMF Autodialer Delay Time.	50MS/100MS/250MS/ <i>450MS</i> /750MS/1000MS
13	DT SPD	Setting of the DTMF Autodialer Sending Speed.	<i>50MS</i> /75MS/100MS
14	DT WRT	Loading of the DTMF Autodialer Memories.	—
15	EDG.BEP	Enables/Disables the Band-edge beeper while selecting the frequency by the DIAL knob.	BEP.ON/ <i>BEP.OFF</i>
16	HM/REV	Selects the alternate function of the [TONE(HM/RV)] key and primary function of the [V/M(MW)] key.	<i>REV</i> /HOME
17	HYPER	Enables/disables the Automatic Writing feature for the Hyper Memory.	MANUAL/ <i>1-AUTO</i> /AUTO
18	I NET	Selects the Internet Connection mode.	<i>INT.COD</i> /INT.MEM
19	INT CD	Selects the Access Number (DTMF digit) for WIRESTM operation.	CODE 0 ~ 9/A/B/C/D/E/F (<i>CODE 1</i>)
20	INT MR	Selects the Access Number (DTMF code) for non-WIRESTM Internet Link System access.	<i>d-1</i> ~ d16
21	LOCK	Selects the Control Locking lockout combination.	LK KEY/LK DIAL/LK K+D/ LK PTT/LK P+K/LK P+D/ LK ALL/ <i>LK OFF</i>
22	MIC	Selects the microphone type to be used.	<i>MH-48</i> /MH-42
23	NAME	Toggle the display indication of the Memory/Home channel between “frequency” and the channel’s “Alpha-numeric Tag.”	<i>FREQ</i> /ALPHA
24	NM WRT	Stores Alpha-Numeric “Tags” for the Memory/Home channels.	—
25	PKT.MIC	Enables/disables the microphone input during Packet operation.	MIC.ON/ <i>MIC.OFF</i>
26	PKT.SPD	Sets the transceiver’s circuitry for the Packet baud rate to be used.	<i>1200bps</i> /9600bps
27	PRG.PNL	Programming the alternate (press and hold in) function of the front panel’s [LOW(ACC)] key.	<i>WX</i> /REV/RPTR/ SQ.OF/LOCK/DIM
28	PRG P1(ACC)	Programming the microphone’s [P1]/[ACC] button assignment.	SQ.OF/TCAL/SSCH/ARTS/WX/
29	PRG P2(P)	Programming the microphone’s [P2]/[P] button assignment.	TN.FQ/DCSC/RPTR/PRI/
30	PRG P3(P1)	Programming the microphone’s [P3]/[P1] button assignment.	<i>LOW</i> (#31)/TONE(#30)/MHz/REV/
31	PRG P4(P2)	Programming the microphone’s [P4]/[P2] button assignment.	HOME/ <i>BAND</i> (#28)/V/M(#29)/SCAN
32	RF SQL	Adjust the RF SQL threshold level.	<i>OFF</i> /S-2 ~ 9/S-FULL
33	RPT.MOD	Sets the Repeater Shift Direction.	<i>RPT.OFF</i> /RPT.-/RPT.+ (×)
34	PRI.RVT	Enables/Disables the Priority Revert feature.	RVT.ON/ <i>RVT.OFF</i>
35	RX MOD	Selects the Receiving mode.	<i>AUTO</i> /FM/AM
36	S SRCH	Selects the Smart Search Sweep mode.	<i>SINGLE</i> /CONT
37	SCAN	Selects the Scan-Resume mode.	TIME/ <i>BUSY</i> /HOLD
38	SCN MD	Selects the Memory Scan channel-selection mode.	<i>MEM</i> /ONLY
39	SHIFT	Sets the magnitude of the Repeater Shift.	0.00 ~ 99.95 MHz (×)
40	SKIP	Selects what action will happen on a “flagged” Memory Channel.	<i>OFF</i> /SKIP/ONLY
41	SPLIT	Enables/Disables split CTCSS/DCS coding.	<i>SPL.OFF</i> /SPL.ON
42	SQL.TYP	Selects the Tone Encoder and/or Decoder mode.	<i>OFF</i> /ENC/ENCODEC/ REV TN/DCS
43	STEP	Sets the Synthesizer steps.	<i>AUTO</i> /5.0 k/10.0 k/12.5 k/ 15.0 k/20.0 k/25.0 k/ 50.0 k/100 k
44	TN FRQ	Sets the CTCSS Tone Frequency.	50 CTCSS Tones (<i>100 Hz</i>)
45	TOT	Sets the Time-Out Timer.	1 ~ 30 minutes or OFF (<i>6 minutes</i>)
46	VFO.BND	Selects or disables the VFO band edge limiting for the current band.	<i>BND</i> .ON/BND.OFF
47	WID.NAR	Reducing the MIC Gain (and Deviation).	<i>WIDE</i> /NARROW
48	WX ALT	Enables/disables the Weather Alert Scan.	ALT.ON/ <i>ALT.OFF</i>

×: Depends on the band of operation.

MENU (“SET”) MODE

	SET MODE ITEM	AVAILABLE VALUES (DEFAULT)
REPEATER SETTING		
Activates/deactivates the Automatic Repeater Shift feature.	4 ARS	ARS.ON/ARS.OFF*
Sets the Repeater Shift Direction.	33 RPT.MOD	RPT.OFF/RPT. -/RPT.+*
Sets the magnitude of the Repeater Shift.	39 SHIFT	0.00 ~ 99.95 MHz*
CTCSS/DCS/DTMF SETTING		
Setting the DCS code.	9 DCS.COD	104 Standard DCS codes (023)
Selects “Normal” or “Inverted” DCS coding.	10 DCS.N/R	TRX N/RX R/TX R/TRX R
Setting of the DTMF Autodialer Delay Time.	12 DT DLY	50MS/100MS/250MS/450MS/ 750MS/1000MS
Setting of the DTMF Autodialer Sending Speed.	13 DT SPD	50MS/75MS/100MS
Loading of the DTMF Autodialer Memories.	14 DT WRT	—
Enables/Disables split CTCSS/DCS coding.	41 SPLIT	SPL.OFF/SPL.ON
Selects the Tone Encoder and/or Decoder mode.	42 SQL.TYP	OFF/ENC/ENCDEC/REV TN/DCS
Sets the Synthesizer steps.	43 STEP	AUTO/ 5.0 k/10.0 k/12.5 k/15.0 k/ 20.0 k/25.0 k/50.0 k/100 k
Sets the CTCSS Tone Frequency.	44 TN FRQ	50 Standard CTCSS Tones (100Hz)
ARTS SETTING		
Selects the ARTS beep mode.	2 AR BEP	INRANG/ALWAYS/OFF
Selects the Polling Interval during ARTS operation	3 AR INT	25sec/15sec
Enables/disables the CW identifier during ARTS operation.	7 CWID	TX ON/TX OFF
Stores your call sign into the CW identifier.	8 CW WRT	—
MEMORY SETTING		
Toggle the display indication of the Memory/Home channel between “frequency” and the channel’s “Alpha-numeric Tag.”	23 NAME	FREQ/ALPHA
Stores Alpha-Numeric “Tags” for the Memory/Home channels.	24NM WRT	—
SCAN SETTING		
Enables/Disables the Priority Revert feature.	34 PRI.RVT	RVT.ON/RVT.OFF
Selects the Smart Search Sweep mode.	36 S SRCH	SINGLE/CONT
Selects the Scan-Resume mode.	37 SCAN	TIME/BUSY/HOLD
Selects the Memory Scan channel-selection mode.	38 SCN MD	MEM/ONLY
Selects what action will happen on a “flagged” Memory Channel.	40 SKIP	OFF/SKIP/MEM
Enables/disables the Weather Alert Scan.	48 WX ALT	ALT.ON/ALT.OFF
POWER SAVE SETTING		
Selects the Automatic Power Off time (time before power goes off).	1 APO	OFF/0.5 H ~ 12.0 H
Sets the Time-Out Timer.	45 TOT	1 ~ 30 minutes or OFF (6 minutes)
DISPLAY SETTING		
Setting of the Display brightness level.	11 DIMMER	DIM 1/DIM 2/DIM 3/DIM.OFF
SWITCH/KNOB SETTING		
Enables/disables the beeper	5 BEEP	KEY/KEY+SC/OFF
Selects the alternate function (press and hold in) of the [TONE(HM/RV)] key and primary function (press momentarily) of the [V/M(MW)] key.	16 HM/REV	REV/HOME
Selects the Control Locking lockout combination.	21 LOCK	LK KEY/LK DIAL/LK K+D/LK PTT/ LK P+K/LK P+D/LK ALL/LK OFF
Programming the alternate (press and hold in) function of the front panel’s [LOW(ACC)] key.	27 PRG.PNL	WX/REV/RPTR/SQ.OF/LOCK/DIM
Programming the microphone’s [P1]/[ACC] button assignment.	28 PRG P1(ACC)	SQ.OF/TCAL/SSCH/ARTS/TN.FQ/
Programming the microphone’s [P2]/[P] button assignment.	29 PRG P2(P)	DCSC/WX/RPTR/PRI/LOW(#31)/
Programming the microphone’s [P3]/[P1] button assignment.	30 PRG P3(P1)	TONE(#30)/MHZ/REV/HOME/
Programming the microphone’s [P4]/[P2] button assignment.	31 PRG P4(P2)	BAND(#28)/V/M(#29)/SCAN
WIRES SETTING		
Selects the Internet Connection mode.	18 I NET	INT.COD/INT.MEM
Selects the Access Number (DTMF digit) for WIRES™ operation.	19 INT CD	CODE 0 ~ 9/A/B/C/D/E/F (CODE 1)
Selects the Access Number (DTMF code) for non-WIRES™ Internet Link System access.	20 INT MR	d-1 ~ d-16
MISCELLANEOUS SETTING		
Shifting of CPU clock frequency.	6 CLK.SFT	SFT.ON/SFT.OFF
Enables/Disables the Band-edge beeper while selecting the frequency by the DIAL knob.	15 EDG.BEP	BEP.ON/BEP.OFF
Enables/disables the Automatic Writing feature for the Hyper Memory.	17 HYPER	MANUAL/1-AUTO/AUTO
Selects the microphone type to be used.	22 MIC	MH-48/MH-42
Enables/disables the microphone input during Packet operation.	25 PKT.MIC	MIC.ON/MIC.OFF
Sets the transceiver’s circuitry for the Packet baud rate to be used.	26 PKT.SPD	1200bps/9600bps
Adjust the RF SQL threshold level.	32 RF SQL	OFF/S-2/S-3/S-4/S-5/S-6/S-7/S-8/ S-9/S-FULL
Selects the Receiving mode.	35 RX MOD	AUTO/FM/AM
Selects or disables the VFO band edge limiting for the current band.	46 VFO.BND	BND.ON/BND.OFF
Reducing the MIC Gain (and Deviation).	47 WID.NAR	WIDE/NARROW

*: Depends on the band of operation.

MENU (“SET”) MODE

Menu #1 [APO]

Function: Selects the Automatic Power Off time (time before power goes off).

Available Values: OFF/0.5 H - 12.0 H in 0.5 hour multiples.

Default: OFF (Disables the APO feature)

Menu #2 [AR BEP]

Function: Selects the ARTS beep mode.

Available Values: INRANG/ALWAYS/OFF

Default: INRANG

INRANG: Activates the ARTS feature; a high tone beep will sound when the transceiver first detects that you are within range, and a low beep will sound when the other station goes out of range.

ALWAYS: Activates the ARTS feature; a high tone beep will sound every time a polling transmission is received from the other station, and a low beep will sound once when the other station goes out of range.

Menu #3 [AR INT]

Function: Selects the Polling Interval during ARTS operation.

Available Values: 25sec/15sec

Default: 25sec

Menu #4 [ARS]

Function: Activates/deactivates the Automatic Repeater Shift feature.

Available Values: ARS.ON/ARS.OFF

Default: Depends on the band of operation.

Menu #5 [BEEP]

Function: Enables/disables the beeper

Available Values: KEY/KEY+SC/OFF

Default: KEY+SC

KEY: The Beeper sounds when you press any key.

KEY+SC: The Beeper sounds when you press a key, or when the scanner stops.

OFF: Disable the beeper.

Menu #6 [CLK.SFT]

Function: Shifting of CPU clock frequency.

Available Values: SFT.ON/SFT.OFF

Default: SFT.OFF

This function is only used to move a spurious response “birdie,” should it fall on a desired frequency.

MENU (“SET”) MODE

Menu #7 [CWID]

Function: Enables/disables the CW identifier during ARTS operation.

Available Values: TX ON/TX OFF

Default: TX OFF

Menu #8 [CW WRT]

Function: Stores your callsign into the CW identifier. Up to six characters may be stored. See page 52 for details.

Menu #9 [DCS.COD]

Function: Setting the DCS code.

Available Values: 104 Standard DCS codes.

Default: DCS.023

DCS CODE									
023	025	026	031	032	036	043	047	051	053
054	065	071	072	073	074	114	115	116	122
125	131	132	134	143	145	152	155	156	162
165	172	174	205	212	223	225	226	243	244
245	246	251	252	255	261	263	265	266	271
274	306	311	315	325	331	332	343	346	351
356	364	365	371	411	412	413	423	431	432
445	446	452	454	455	462	464	465	466	503
506	516	523	526	532	546	565	606	612	624
627	631	632	654	662	664	703	712	723	731
732	734	743	754	-	-	-	-	-	-

Menu #10 [DCS.N/R]

Function: Selects “Normal” or “Inverted” DCS coding.

Available Values: T/RX N, RX R, TX R, T/RX R

Default: T/RX N

Menu #11 [DIMMER]

Function: Setting of the Display brightness level.

Available Values: DIM 1/DIM 2/DIM 3/DIM.OFF

Default: DIM 1

Menu #12 [DT DLY]

Function: Setting of the DTMF Autodialer Delay Time.

Available Values: 50MS/100MS/250MS/450MS/750MS/1000MS.

Default: 450MS

Menu #13 [DT SPD]

Function: Setting of the DTMF Autodialer Sending Speed.

Available Values: 50MS (high speed)/75MS (mid speed)/100MS (low speed) (ms)

Default: 50MS

Menu #14 [DT WRT]

Function: Loading of the DTMF Autodialer Memories. See page 54 for details.

Menu #15 [EDG.BEP]

Function: Enables/Disables the Band-edge beeper while selecting the frequency by the **DIAL** knob.

Available Values: BEP.ON/BEP.OFF

Default: BEP.OFF

MENU (“SET”) MODE

Menu #16 [HM/REV]

Function: Selects the alternate function (press and hold in) of the [TONE(HM/RV)] key and primary function (press momentarily) of the [V/M(MW)] key.

Available Values: REV/HOME

Default: REV

Selection	Primary function of the [V/M(MW)] key	Alternate function of the [TONE(HM/RV)] key
REV	Press the [V/M(MW)] key momentarily to switch the frequency control among the VFO, Memory System, and Home channel.	Press and hold in the [TONE(HM/RV)] key for 1/2 second to reverse the transmit and receive frequencies during repeater operation.
HOME	Press the [V/M(MW)] key momentarily to switch the frequency control between the VFO and Memory System.	Press and hold in the [TONE(HM/RV)] key for 1/2 second to recall a favorite “Home” channel.

Menu #17 [HYPER]

Function: Enables/disables the Automatic Writing feature for the Hyper Memory.

Available Values: MANUAL/1-AUTO/AUTO

Default: 1-AUTO

MANUAL: Disables the Automatic Writing feature.

1-AUTO: Enables the Automatic Writing feature to the Hyper Memory “1” only. The Hyper memory data changes automatically when the radio’s configuration is changed (such as Mode change, Band change, etc.). Disable the Automatic Writing feature to the Hyper Memory “2” through “5.”

AUTO: Enables the Automatic Writing feature to the all Hyper Memoirs.

Menu #18 [I NET]

Function: Selects the Internet Connection mode.

Available Values: INT.COD/INT.MEM

Default: INT.COD

INT.COD: Sets up the Internet Connection mode for WIRES™ access.

INT.MEM: Sets up the Internet Connection mode for other (DTMF string) Internet Link System access.

Menu #19 [INT CD]

Function: Selects the Access Number (DTMF digit) for WIRES™ operation.

Available Values: CODE “0” ~ CODE “9,” CODE “A,” CODE “B,” CODE “C,” CODE “D,” CODE “E(※),” CODE “F(#)”

Default: CODE “1”

MENU (“SET”) MODE

Menu #20 [INET M]

Function: Selects the Access Number (DTMF code) for non-WIRES™ Internet Link System access.

Available Values: d- 1 ~ d-16

Default: d- 1

Menu #21 [LOCK]

Function: Selects the Control Locking lockout combination.

Available Values: LK KEY/LK DIAL/LK K+D/LK PTT/LK P+K/LK P+D/LK ALL/LK OFF

Default: LK OFF

Note: “K” = “KEY,” “D” = “DIAL,” “P” = “PTT”

Menu #22 [MIC]

Function: Selects the microphone type to be used.

Available Values: MH-48/MH-42

Default: MH-48

Menu #23 [NAME]

Function: Toggles the display indication of the Memory/Home channel between “frequency” and the channel’s “Alpha-numeric Tag.”

Available Values: FREQ/ALPHA

Menu #24 [NM WRT]

Function: Stores Alpha-Numeric “Tags” for the Memory/Home channels.

See page 35 for details.

Menu #25 [PKT.MIC]

Function: Enables/disables the microphone input during Packet operation.

Available Values: MIC.ON/MIC.OFF

Default: MIC.OFF

Menu #26 [PKT.SPD]

Function: Sets the transceiver’s circuitry for the Packet baud rate to be used.

Available Values: 1200bps/9600bps

Default: 1200bps

Menu #27 [PRG.PNL]

Function: Programming the alternate (press and hold in) function of the front panel’s [LOW(ACC)] key. See page 60 for details.

Available Values: WX/REV/RPTR/SQ.OF/LOCK/DIM

Default: WX

MENU (“SET”) MODE

Menu #28 [PRG P1 (PRG ACC)]

Function: Programming the microphone’s [P1]/[ACC] button assignment. See page 60 for details.

Available Values: SQ.OF/TCAL/SSCH/ARTS/TN.FQ/DCSC/WX/RPTR/PRI/LOW/TONE/MHz/REV/HOME/BAND/(V/M)/SCAN

Default: BAND

Menu #29 [PRG P2 (PRG P)]

Function: Programming the microphone’s [P2]/[P] button assignment. See page 60 for details.

Available Values: SQ.OF/TCAL/SSCH/ARTS/TN.FQ/DCSC/WX/RPTR/PRI/LOW/TONE/MHz/REV/HOME/BAND/(V/M)/SCAN

Default: V/M

Menu #30 [PRG P3 (PRG P1)]

Function: Programming the microphone’s [P3]/[P1] button assignment. See page 60 for details.

Available Values: SQ.OF/TCAL/SSCH/ARTS/TN.FQ/DCSC/WX/RPTR/PRI/LOW/TONE/MHz/REV/HOME/BAND/(V/M)/SCAN

Default: TONE

Menu #31 [PRG P4 (PRG P2)]

Function: Programming the microphone’s [P4]/[P2] button assignment. See page 60 for details.

Available Values: SQ.OF/TCAL/SSCH/ARTS/TN.FQ/DCSC/WX/RPTR/PRI/LOW/TONE/MHz/REV/HOME/BAND/(V/M)/SCAN

Default: LOW

Menu #32 [RF SQL]

Function: Adjusts the RF SQL threshold level.

Available Values: OFF/S-2/S-3/S-4/S-5/S-6/S-7/S-8/S-9/S-FULL

Default: OFF

Menu #33 [RPT.MOD]

Function: Sets the Repeater Shift Direction

Available Values: RPT.OFF/RPT. –/RPT. +

Default: Depends on the band of operation.

Menu #34 [PRI.RVT]

Function: Enables/Disables the Priority Revert feature.

Available Values: RVT.ON/RVT.OFF

Default: RVT.OFF

MENU (“SET”) MODE

Menu #35 [RX MOD]

Function: Selects the Receiving mode.

Available Values: AUTO/FM/AM

Default: AUTO (Mode automatically changes according to operating frequency.)

Menu #36 [S SRCH]

Function: Selects the Smart Search Sweep mode.

Available Values: SINGLE/CONT

Default: SINGLE

SINGLE: The transceiver sweeps the current band once in each direction starting on the current frequency. All channels where activity is present (up to 15 in each direction) are loaded into the Smart Search memories. Whether or not all 31 memories are filled, the search stops after one sweep in each direction.

CONT: The transceiver makes a sweep in each direction as with the “Single” mode, but if all 31 channels are not filled after the first sweep, the radio continues sweeping until they are all filled.

Menu #37 [SCAN]

Function: Selects the Scan-Resume mode.

Available Values: TIME/BUSY/HOLD

Default: BUSY

BUSY: The scanner will halt on a signal it encounters. Two seconds after the carrier has dropped because the other station(s) ceased transmission, the scanner will resume.

TIME: The scanner will halt on a signal it encounters, and will hold five seconds. If you do not take action to disable the scanner within five seconds, the scanner will resume even if the stations are still active.

HOLD: The scanner will stop when a signal is received, and will not restart.

Menu #38 [SCN MD]

Function: Selects the Memory Scan channel-selection mode.

Available Values: MEM/ONLY

Default: MEM

MEM: The scanner will “skip” the flagged channels during scanning.

ONLY: The scanner will only scan channels that are flagged (Preferential Scan List).

Menu #39 [SHIFT]

Function: Sets the magnitude of the Repeater Shift.

Available Values: 0.00 - 99.95 MHz (50 kHz step)

Default: Depends on the band of operation.

MENU (“SET”) MODE

Menu #40 [SKIP]

Function: Selects what action will happen on a “flagged” Memory Channel

Available Values: OFF/SKIP/ONLY

Default: OFF

OFF: All memory channels will be scanned (the “flag” will be ignored).

SKIP: The scanner will “skip” the flagged (“SKIP”) channels during scanning.

ONLY: The scanner will only scan the flagged (Preferential) channels during scanning.

Menu #41 [SPLIT]

Function: Enables/Disables split CTCSS/DCS coding.

Available Values: SPL.OFF/SPL.ON

Default: SPL.OFF

When this Menu Item is set to “ON,” you can see the following additional parameters after the “DCS” parameter while selecting the Menu #42: SQL.TYP.

D: DCS Encode only

(the “**DCS**” icon will blink during operation)

ENC DCS: Encodes a CTCSS Tone and Decodes a DCS code

(the “**DCS**” and “**ENC**” icons will appear during operation)

D-DEC: Encodes a DCS code and Decodes a CTCSS Tone

(the “**DCS**” icon will blink and the “**DEC**” icon will appear during operation)

Select the desired operating mode from the selections shown above.

Menu #42 [SQL.TYP]

Function: Selects the Tone Encoder and/or Decoder mode.

Available Values: OFF/ENC/ENCDEC/REV TN/DCS

Default: OFF

ENC: CTCSS Encoder

ENC DEC: CTCSS Encoder/Decoder

REV TN: Reverse CTCSS Decoder

DCS: Digital Code Squelch Encoder/Decoder

Menu #43 [STEP]

Function: Sets the Synthesizer steps.

Available Values: AUTO/5.0 k/10.0 k/12.5 k/15.0 k/20.0 k/25.0 k/50.0 k/100 k

Default: Depends on the band of operation.

Note: 5 kHz and 15 kHz steps are not available for use on above 700 MHz.

MENU (“SET”) MODE

Menu #44 [TN FRQ]

Function: Sets the CTCSS Tone Frequency.

Available Values: 50 Standard CTCSS Tones

Default: 100 Hz

Note: This Menu Item can be set independently for each band, and independently in each memory.

CTCSS TONE FREQUENCY (Hz)					
67.0	69.3	71.9	74.4	77.0	79.7
82.5	85.4	88.5	91.5	94.8	97.4
100.0	103.5	107.2	110.9	114.8	118.8
123.0	127.3	131.8	136.5	141.3	146.2
151.4	156.7	159.8	162.2	165.5	167.9
171.3	173.8	177.3	179.9	183.5	186.2
189.9	192.8	196.6	199.5	203.5	206.5
210.7	218.1	225.7	229.1	233.6	241.8
250.3	254.1	–	–	–	–

Menu #45 [TOT]

Function: Sets the Time-Out Timer.

Available Values: 1 - 30 minutes or OFF

Default: 6 minutes

Menu #46 [VFO.BND]

Function: Selects or disables the VFO band edge limiting for the current band.

Available Values: BND.ON/BND.OFF

Default: BND.ON

BND.ON: When the VFO frequency reaches the high band edge of the current band, the VFO frequency will jump to the low band edge of the current band (or vice versa).

BND.OFF: When the VFO frequency reaches the high edge of the current band, the VFO frequency will jump to the low band edge of the next band (or vice versa).

Menu #47 [WID.NAR]

Function: Reducing the MIC Gain (and Deviation).

Available Values: WIDE/NARROW

Default: WIDE

Note: This Menu Item can be set independently for each band.

Menu #48 [WX ALT]

Function: Enables/disables the Weather Alert Scan feature

Available Values: ALT.ON/ALT.OFF

Default: ALT.OFF

“AUTO” MODE PRESET OPERATING PARAMETERS

USA Version

FREQUENCY RANGE (MHz)	MODE	STEP
108.000 - 137.000	AM	25 kHz
137.000 - 144.000	FM	12.5 kHz
144.000 - 148.000	FM	5 kHz
148.000 - 156.000	FM	12.5 kHz
156.000 - 157.450	FM	25 kHz
157.450 - 160.600	FM	12.5 kHz
160.600 - 160.975	FM	25 kHz
160.975 - 161.500	FM	12.5 kHz
161.500 - 162.900	FM	25 kHz
162.900 - 174.000	FM	12.5 kHz
174.000 - 222.000	FM	50 kHz
222.000 - 225.000	FM	5 kHz
225.000 - 300.000	FM	12.5 kHz
300.000 - 336.000	AM	100 kHz
336.000 - 420.000	FM	12.5 kHz
420.000 - 450.000	FM	25 kHz
450.000 - 470.000	FM	12.5 kHz
470.000 - 520.000	FM	50 kHz
700.000 - 800.000	FM	50 kHz
803.000 - 999.990	FM	12.5 kHz

EXP Version

FREQUENCY RANGE (MHz)	MODE	STEP
108.000 - 137.000	AM	25 kHz
137.000 - 160.600	FM	12.5 kHz
160.600 - 162.025	FM	25 kHz
162.025 - 174.000	FM	12.5 kHz
174.000 - 222.000	FM	50 kHz
222.000 - 300.000	FM	12.5 kHz
300.000 - 320.000	AM	25 kHz
320.000 - 420.000	FM	12.5 kHz
420.000 - 430.000	FM	12.5 kHz
430.000 - 440.000	FM	25 kHz
440.000 - 470.000	FM	12.5 kHz
470.000 - 520.000	FM	50 kHz
700.000 - 800.000	FM	50 kHz
800.000 - 999.990	FM	12.5 kHz

Cellular Blocked

1. Changes or modifications to this device not expressly approved by VERTEX STANDARD could void the user's authorization to operate this device.
2. This device complies with part 15 of the FCC Rules. Operation is subject to the following two conditions; (1) This device may not cause harmful interference, and (2) this device must accept any interference including received, interference that may cause undesired operation.
3. The scanning receiver in this equipment is incapable of tuning, or readily being altered, by the User to operate within the frequency bands allocated to the Domestic public Cellular Telecommunications Service in Part 22.

Part 15.21: Changes or modifications to this device not expressly approved by Vertex Standard could void the user's authorization to operate this device.

DECLARATION BY MANUFACTURER

The Scanner receiver is not a digital scanner and is incapable of being converted or modified to a digital scanner receiver by any user.

WARNING: MODIFICATION OF THIS DEVICE TO RECEIVE CELLULAR RADIOTELEPHONE SERVICE SIGNALS IS PROHIBITED UNDER FCC RULES AND FEDERAL LAW.



Copyright 2003
VERTEX STANDARD CO., LTD.
All rights reserved.

Printed in Japan

No portion of this manual
may be reproduced
without the permission of
VERTEX STANDARD CO., LTD.



E H O 1 6 M 1 0 0

0310A-0T